

D

D20
Manual 1.6 en

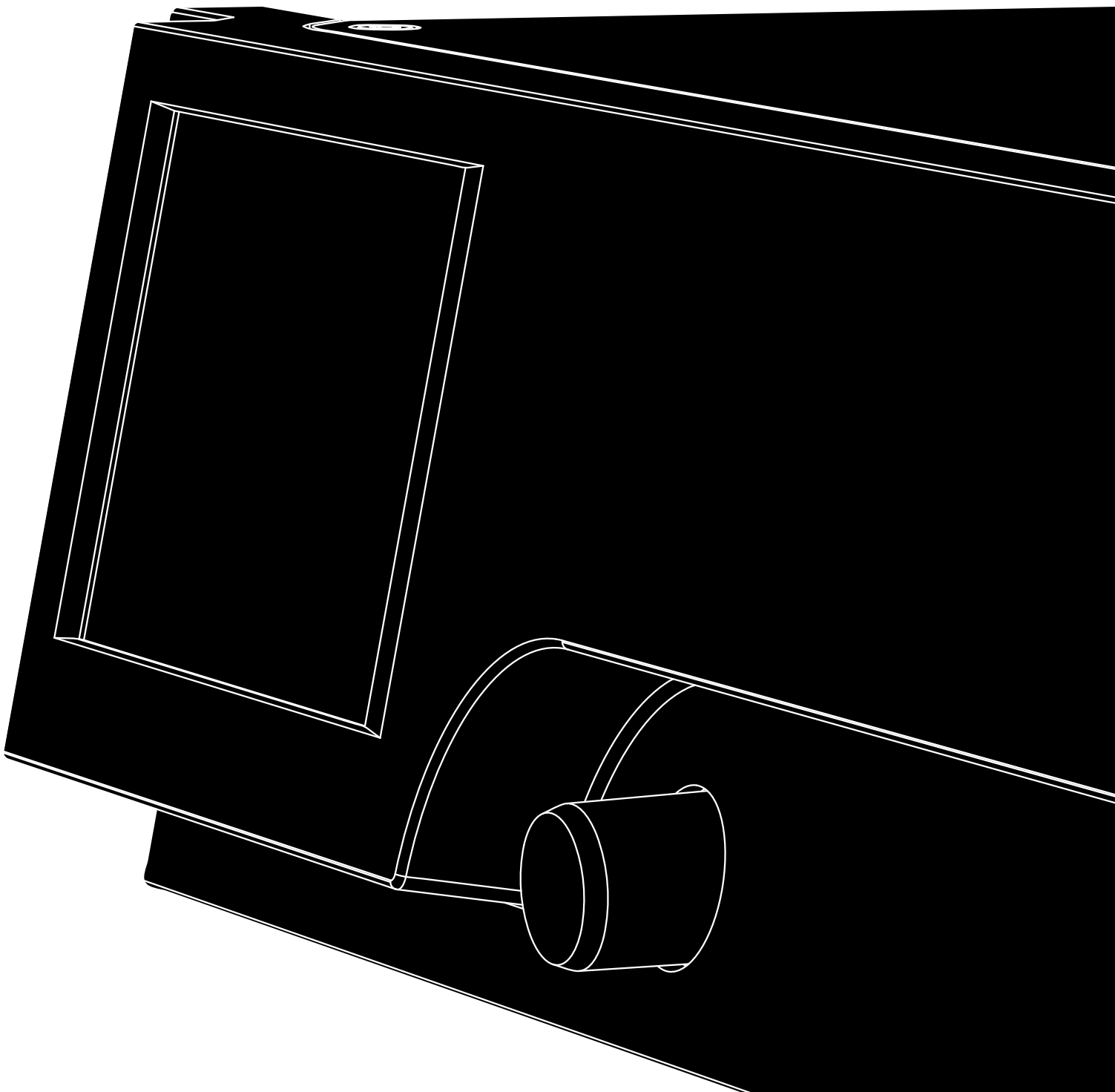

General information

D20 Manual

Version: 1.6 en, 04/2016, D2025.EN .01

Copyright © 2016 by d&b audiotechnik GmbH; all rights reserved.

Keep this manual with the product or in a safe place so that it is available for future reference.

We recommend you to regularly check the d&b website for the latest version of this manual.

When reselling this product, hand over this manual to the new owner.

If you supply d&b products, please draw the attention of your customers to this manual. Enclose the relevant manuals with the systems. If you require additional manuals for this purpose, you can order them from d&b.

d&b audiotechnik GmbH
Eugen-Adolff-Strasse 134, D-71522 Backnang, Germany
T +49-7191-9669-0, F +49-7191-95 00 00
docadmin@dbaudio.com, www.dbaudio.com

IMPORTANT SAFETY INSTRUCTIONS

Explanation of graphical symbols



The lightning symbol within a triangle is intended to alert the user to the presence of uninsulated "dangerous voltages" within the unit's chassis that may be of sufficient magnitude to constitute a risk of electric shock to humans.



The exclamation point within a triangle is intended to alert the user to the presence of important operating and service instructions in the literature accompanying the product.

Before using this product, carefully read the applicable items of the following safety instructions.

1. Keep these instructions for future reference.
2. Read these instructions.
3. Heed all warnings.
4. Follow all instructions.
5. Keep water or other liquids away from the unit. Do not place liquid filled containers, for example beverages, on top of the unit.
6. Do not operate the unit while it is wet or standing in liquid.
7. Always operate the unit with the chassis ground wire connected to the electrical safety earth. Do not defeat the safety purpose of a grounding-type plug. A grounding-type plug has two blades and a third grounding prong. The third prong is provided for your safety. If the provided plug does not fit into your outlet, consult an electrician for replacement of the obsolete outlet.
8. Do not use this unit if the power cord is damaged or frayed. Protect the power cord from being walked upon or pinched, particularly at the plugs and the point where it exits from the apparatus.
9. The unit is intended for use in a 19" rack. Follow the mounting instructions. When a rack on wheels is used, exercise caution when moving the loaded rack to avoid injury from tipping over.
10. Unplug this apparatus during lightning storms or when unused for long periods of time.
11. Never connect an output pin to any other amplifier input or output pin or to the earth (ground). This may damage the unit or lead to electric shock.
12. Lay all cables connected to the unit carefully so that they cannot be crushed by vehicles or other equipment and that no one can either step on them or trip over them.
13. Refer all servicing to qualified service personnel. Servicing is required when the apparatus has been damaged in any way such as:
 - Power-supply cord or plug is damaged.
 - Liquid has been spilled into the unit.
 - An object has fallen into the unit.
 - The unit has been exposed to rain or moisture.
 - The unit does not operate normally.
 - The unit was dropped or the chassis is damaged.
 - Do not remove top or bottom covers. Removal of the covers will expose hazardous voltages. There are no user serviceable parts inside and removal may void the warranty.
14. Use the mains plug as the disconnecting device and keep it readily accessible. If the mains plug is not readily accessible due to mounting in a 19" rack, then the mains plug for the entire rack must be readily accessible.
15. An experienced user must always supervise the equipment, especially if inexperienced adults or minors are using the equipment.

1. Scope of supply	6
2. Intended use	7
2.1. Loudspeaker types.....	7
3. D20 Concept	8
4. Technical specifications	10
5. Overview	12
5.1. Connections.....	12
5.2. Controls and indicators - User interface.....	13
6. Startup	14
6.1. Rack mounting and cooling.....	14
6.2. Connections.....	16
6.2.1. Mains connection.....	16
6.2.2. Audio INPUT and LINK connectors.....	17
6.2.3. Output connectors.....	18
6.2.4. ETHERNET (Dual Ethernet port).....	20
6.2.5. CAN (CAN-Bus).....	21
6.3. Controls and indicators.....	22
6.3.1. Mains power switch.....	22
6.3.2. Display - User interface.....	22
6.3.3. Standby mode.....	23
6.3.4. Mute functions.....	24
7. User interface	25
7.1. Operating concept.....	25
7.2. Screen layout and conventions.....	26
7.3. Screen items and views.....	26
7.3.1. Function buttons.....	26
7.3.2. Navigation buttons.....	26
7.3.3. Input fields.....	27
7.3.4. Input masks.....	27
7.3.5. Information fields.....	27
8. Home screen	28
8.1. Header area - Device.....	29
8.2. Data area - Channel strip(s).....	29
9. Channel strip	30
10. Basic settings - Quick reference	32
11. Device setup	34
11.1. Device name.....	35
11.2. Input.....	36
11.2.1. Input mode.....	36
11.2.2. Input settings.....	38
11.2.2.1. Input monitoring.....	38
11.2.2.2. Input gain.....	40
11.2.2.3. Fallback.....	41
11.2.2.4. Override.....	43
11.3. Output.....	45
11.3.1. Output mode.....	46
11.4. Remote.....	49
11.4.1. IP settings.....	49
11.4.2. Remote ID.....	50
11.5. More.....	51
11.5.1. Preferences.....	51
11.5.1.1. Display.....	51

11.5.1.2.	Lock.....	52
11.5.1.3.	Preferences/More.....	54
11.5.1.3.1.	System reset.....	54
11.5.2.	Info.....	55
11.5.3.	Levels.....	56
11.5.4.	AmpPresets.....	57
11.5.5.	Scope.....	58
11.5.6.	AutoStandby.....	59
12.	Channel setup.....	61
12.1.	Channel name.....	62
12.2.	Configuration switches - Filter_1, _2, _3.....	63
12.3.	Level.....	63
12.4.	EQ - Equalizer	64
12.5.	DLY - Delay.....	67
12.6.	Input routing.....	67
12.7.	System check/LM.....	69
12.7.1.	System check.....	69
12.7.2.	Load monitoring (LM).....	70
12.8.	Speaker.....	71
12.8.1.	ArrayProcessing (AP).....	73
12.8.2.	LoadMatch.....	74
12.8.3.	LINEAR setup.....	75
12.9.	Channel linking.....	76
12.10.	Frequency generator - Freq. gen.....	77
13.	Web Remote interface.....	78
14.	Operation (Hardware references).....	84
14.1.	Power supply.....	84
14.1.1.	Active Power Factor Correction (PFC).....	84
14.1.2.	Mains voltage monitoring.....	84
14.1.3.	Rated mains voltage.....	84
14.1.4.	Mains supply requirements.....	85
14.1.5.	Generator operation/UPS requirements.....	86
14.2.	Power amplifiers.....	86
14.3.	Cooling fans.....	86
14.4.	Current/power draw and thermal dissipation.....	87
15.	Service/Maintenance and care.....	89
15.1.	Service.....	89
15.2.	Maintenance and care.....	89
15.2.1.	Touch screen cleaning.....	89
15.2.2.	Touch screen calibration.....	90
16.	Manufacturer's Declarations.....	91
16.1.	EU declaration of conformity (CE symbol).....	91
16.2.	WEEE Declaration (Disposal).....	91
16.3.	Licenses and Copyright.....	91
17.	Appendix.....	92
17.1.	System check - References.....	92
17.1.1.	Typical impedance (Z) values.....	92
17.1.2.	Max. number of cabinets operated in parallel.....	94
17.2.	Possible error messages.....	96

1. Scope of supply

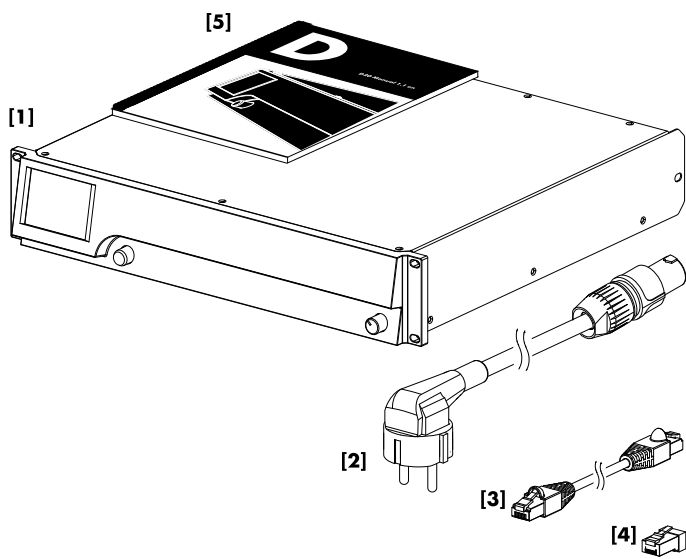

Before starting up the device, please verify the shipment for completeness and proper condition of the items.

If there is any sign of obvious damage to the unit and/or the power cord, do not operate the unit and contact your local dealer from whom you received it.

Pos.	Qty.	d&b Code	Description
[1]	1	Z2750	d&b D20 Amplifier.
Including:			
[2]	1	Z2610.xxx	Power cord D20 (specific to country).
[3]	1	K6007.050	RJ 45 Patch cable, 0.5 m (1.6 ft) CAT 6/AWG 24-STP (shielded twisted pair) to be used for daisy chaining multiple amplifiers within a rack.
[4]	1	Z6116	RJ 45 M Terminator for terminating the last device of a CAN-Bus segment.
[5]	1	D2025.EN .01	D20 Manual.

2. Intended use

The d&b D20 amplifier is designed for mobile applications and intended to be used with applicable d&b loudspeakers. A LINEAR setup is available allowing the D20 to be used as a linear power amplifier.

NOTICE!

The device complies with the electromagnetic compatibility requirements of EN 55103 (product family standard for audio, video, audio-visual and entertainment lighting control apparatus for professional use) for the environments E1 (residential), E2 (business and commercial), E3 (outdoor use in urban areas) and E4 (outdoor use in rural areas).

Acoustic interference and malfunctions may occur if the unit is operated in the immediate vicinity of high-frequency transmitters (e.g. wireless microphones, mobile phones, etc.). Damage to the device is unlikely, but cannot be excluded.

2.1. Loudspeaker types

The maximum number of cabinets driven by each channel varies depending on their nominal impedance. It can be found in the respective loudspeaker manual and also in the data section of each loudspeaker on the d&b website at www.dbaudio.com.

The minimum recommended impedance per channel is 4 ohms.

Nom. impedance	Cabinets per channel
4 Ω	1
8 Ω	2
12 Ω	3
16 Ω	4

A list of d&b loudspeakers supported by the amplifier is included in the Release notes of the amplifier firmware. The latest version can be found on the d&b website at www.dbaudio.com.

3. D20 Concept

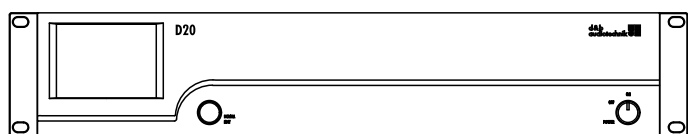

D20 Front view

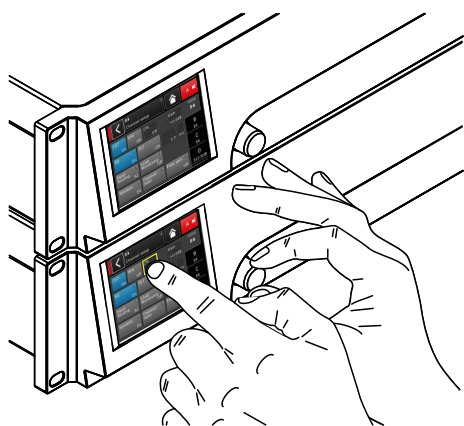

D20 User interface

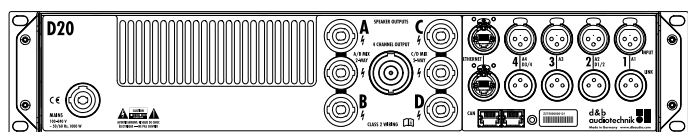

D20 Rear view

The D20 amplifier represents the next generation of four channel Class D amplifiers. It is developed and manufactured by d&b using Digital Signal Processing (DSP) to incorporate loudspeaker specific configurations and user definable setups, equalization and delay functions. The amplifier is designed to drive applicable d&b loudspeakers and provide comprehensive management and protection capabilities. This high performance amplifier provides the power density required for both touring and installation purposes while the powerful signal processing extends the level of functionality of the on-board features.

The user interface of the amplifier consists of two elements: a color TFT touch screen providing visual information and quick access to the amplifier settings and a rotary encoder on the front panel for data input purposes. To allow ease of operation when the amplifier is below eye level, the front panel and the integrated display are tilted upwards. As a result, the front panels of multiple amplifiers on top of each other within a rack integrate to form one large control surface.

The user definable equalizer features two independent 16-band EQ groups within each channel. These provide parametric, notch, shelving and asymmetric filters as well as a graphic EQ (via the d&b R1 Remote control software V2) allowing instant switching between two EQ curves for comparison. The delay capability covers a range of up to 10 s. All loudspeaker specific functions such as CUT, HFA, HFC, CSA or CPL are available. The DSP unit of the amplifier has a fixed latency of 0.3 ms.

The amplifier enables up to four input channels, which may be four analog inputs, two analog and two AES3 channels or four AES3 channels. Each input channel can be routed to any of the output channels A to D. XLR connectors 2 and 4 of the D20 can be used as either digital or analog inputs, connectors 1 and 3 are analog inputs. Link outputs are supplied for all inputs. This 1:1 ratio of inputs to amplifier output channels increases flexibility of application, particularly for use as monitor, frontfill or effect channels.

The D20 amplifier outputs are NL4 connectors plus one centered NL8 connector with all pins driven. The latter serves as an interface to a rack panel or to loudspeaker multicores and breakout adapters. To simplify configuration, the output mode of the amplifier can be configured like a set of two dual channel amplifiers providing Dual Channel, Mix TOP/SUB or 2-Way Active modes for the left and the right channels A/B and C/D, respectively.

For applicable loudspeakers, d&b LoadMatch enables the D20 amplifier to electrically compensate for the properties of the cable used to connect the loudspeakers to the amplifier output. This function which covers a bandwidth of up to 20 kHz preserves the tonal balance when cable lengths of up to 70 m (230 ft) are used. Due to its design LoadMatch does not require additional wires and is therefore applicable with any connector type used. To provide optimum compensation, cable length and cross-sectional data as well as the number of loudspeakers connected to the amplifier channel can be entered on the amplifier.

The D20 utilizes a switch mode power supply with active Power Factor Correction (PFC) to produce a clean current draw and ensure stable and efficient performance under adverse mains conditions. The high power capabilities provide increased power to fully drive all applicable d&b loudspeaker cabinets and sufficient headroom for any future systems.

Remote control and full system integration are realized using the d&b ArrayCalc simulation software and R1 Remote control software V2. The D20 amplifier includes two Ethernet ports on etherCON connectors. Both, Ethernet and dBcAN protocols are incorporated. The Ethernet protocol implemented in the d&b R1 Remote control software V2 and the D20 amplifier is a protocol developed by the OCA Alliance (Open Control Architecture Alliance), of which d&b is a founding member. For further details, please refer to the OCA website: www.oca-alliance.com.

4. Technical specifications

Audio data (linear setting with subsonic filter)

Maximum output power per channel (THD + N < 0.5%, all channels driven)	
CF = 6 dB @ 4/8 ohms	4 x 1000/800 W
CF = 12 dB @ 4/8 ohms	4 x 1600/800 W
Maximum output voltage	117 V
Frequency response (-1 dB)	35 Hz - 25 kHz
THD+N (20 Hz - 20 kHz, 200 W @ 4 ohms)	< 0.5%
S/N ratio (unweighted, RMS)	
Analog input	> 104 dBr
Digital input	> 106 dBr
Damping factor (20 Hz - 200 Hz into 4 ohms)	> 80
Crosstalk (20 Hz - 20 kHz)	> -45 dBr
Gain (Linear mode @ 0 dB)	31 dB

Protection circuits

Output current protection	45 A
Overvoltage protection	Up to 400 VAC
Self-resetting overtemperature protection	
Output DC offset protection	
Output HF Voltage Limiter	
Output pop-noise suppression	

Power supply

Universal range switched mode power supply with active power factor correction (PFC)	
Mains connector	powerCON
Rated mains voltage	100 to 240 V, 50 - 60 Hz
Mains fuse	internal

Power consumption (typical values)

Standby	9 W
Idle	48 W
Max. power consumption (short term RMS)	2.2 kW

Audio input connectors

INPUT analog (A1 - A4)	3 pin XLR female
Pin assignment	1 = GND, 2 = pos., 3 = neg.
Input impedance	38 kOhms, electronically balanced
Common mode rejection (CMRR @ 100 Hz/10 kHz)	> 60 / 50 dB
Maximum input level (balanced/unbalanced)	+23 / 29 dBu
.....	+27 dBu @ 0 dBFS
LINK analog (A1 - A4)	3 pin XLR male
Pin assignment	1 = GND, 2 = pos., 3 = neg.
.....	parallel to input
INPUT digital (D1/2, D3/4)	3 pin XLR female, AES 3
Pin assignment	1 = GND, 2 = AES Signal, 3 = AES Signal
Input impedance	110 ohms, transformer balanced
Sampling	48 / 96 kHz / 2 Ch/n
Synchronization	Word-Sync: PLL-locked to source (slave mode)
LINK digital (Output)	3 pin XLR male
.....	electronically balanced
.....	analog signal buffering (refresh), power fail relay (Bypass)

Output connectors

SPEAKER OUTPUTS A/B/C/D	4 x NL4
A/B MIX/2-WAY, C/D MIX/2-WAY	2 x NL4
4 CHANNEL OUTPUT	1 x NL8

Network connectors

CAN	2 x RJ 45 parallel
ETHERNET	2 x etherCON®
.....	Dual Ethernet port with built-in 2-port Ethernet switch
.....	10/100 Mbit

Controls and indicators

POWER	Mains power switch
SCROLL/EDIT	Digital rotary encoder
Display	TFT color touch screen, 3.5" / 320 x 240 Pixel

Digital Signal Processing

System start-up time	17 sec.
Sampling rate	96 kHz / 27 Bit ADC / 24 Bit DAC
Latency analog input	0.3 msec.
Latency digital input (AES)	0.3 msec.
.....	48 kHz / 96 kHz
Input dynamic	> 124 dB
ADC dynamic	> 110 dB
DAC dynamic	> 110 dB
Equalizer	two user definable 16-band equalizers
.....	Filter types: PEQ/Notch/HiShlv/LoShlv/Asym
Delay	0.3 msec. - 10 sec.
Frequency generator	Pink noise or Sine wave 10 Hz - 20 kHz

Operating conditions

Temperature range*	-10 °C ... +40 °C / +14 °F ... +104 °F
.....	* continuous operation
Temperature range**	-10 °C ... +50 °C / +14 °F ... +122 °F
.....	** reduced output power or short term operation
Storage temperature	-20 °C ... +70 °C / -4 °F ... +158 °F
Humidity (rel.), long term average	70%

Fan noise emission

Rack mounted, measured on axis, 1 m to front panel, A-weighting	
Idle	32 dB(A)
Max. RPM	48 dB(A)
.....	Ambient temperature 22 °C / 71.6 °F

Dimensions and weight

Height x width x depth	2 RU x 19" x 460 mm
.....	2 RU x 19" x 18.1"
Weight	10.8 kg / 23.8 lb

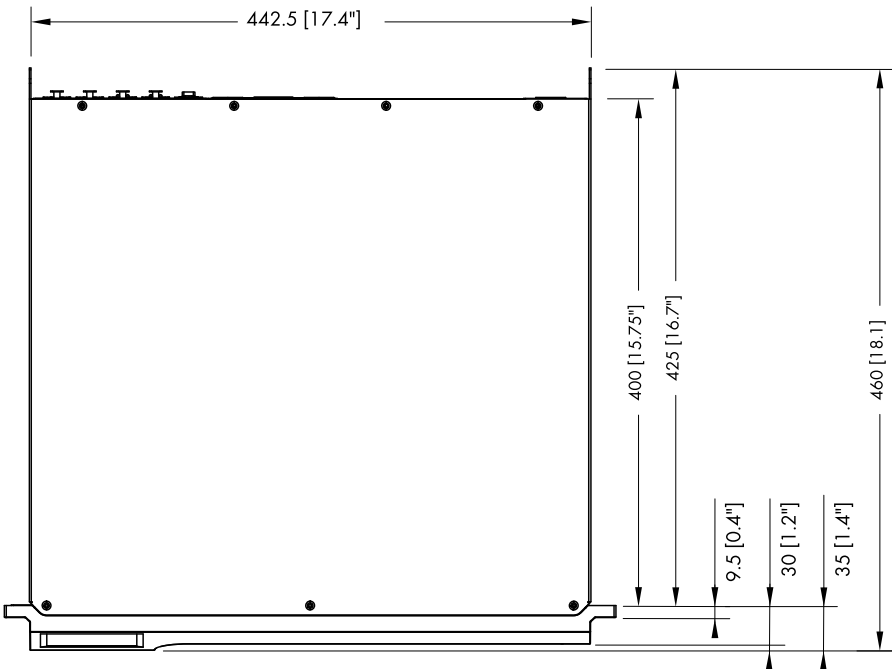
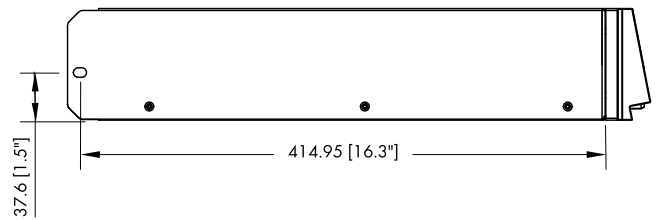
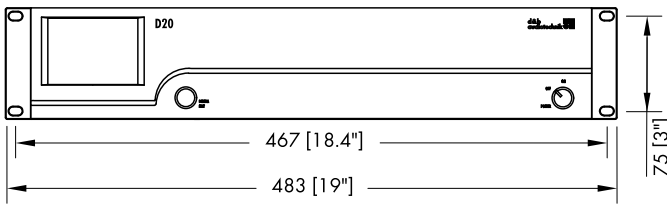

D20 enclosure dimensions in mm [inch]

5.1. Connections

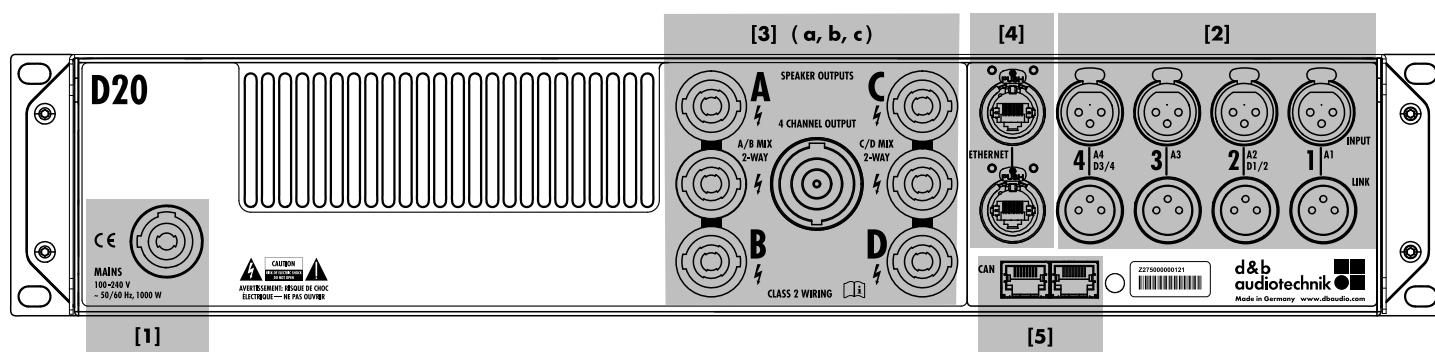

[1] Mains connector socket.
Refer to ⇒ Chapter 6.2.1. "Mains connection" on page 16 and ⇒ Chapter 14.1.4. "Mains supply requirements" on page 85.

[3] Output connector panel, dependent on chosen output option (NL4 or EP5 output connectors).
Refer to ⇒ Chapter 6.2.3. "Output connectors" on page 18.

[2] Audio INPUT (analog/digital) and LINK connectors.
Refer to ⇒ Chapter 6.2.2. "Audio INPUT and LINK connectors" on page 17.

[4] ETHERNET.
Refer to ⇒ Chapter 6.2.4. "ETHERNET (Dual Ethernet port)" on page 20.

[5] CAN (CAN-Bus).
Refer to ⇒ Chapter 6.2.5. "CAN (CAN-Bus)" on page 21.

5.2. Controls and indicators - User interface

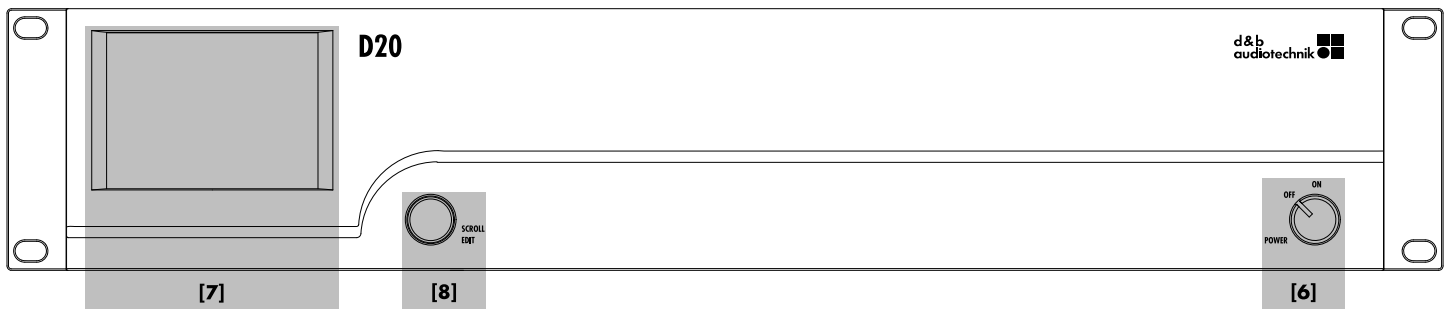

- [7] 3.5" TFT color touch screen.
- [8] Rotary encoder SCROLL/EDIT.
Refer to ⇒ Chapter 6.3. "Controls and indicators" on page 22 and ⇒ Chapter 7. "User interface" on page 25.

- [6] Mains power switch.
Refer to ⇒ Chapter 6.3. "Controls and indicators" on page 22, following ⇒ Chapter 6.3.1. "Mains power switch" on page 22.

6. Startup

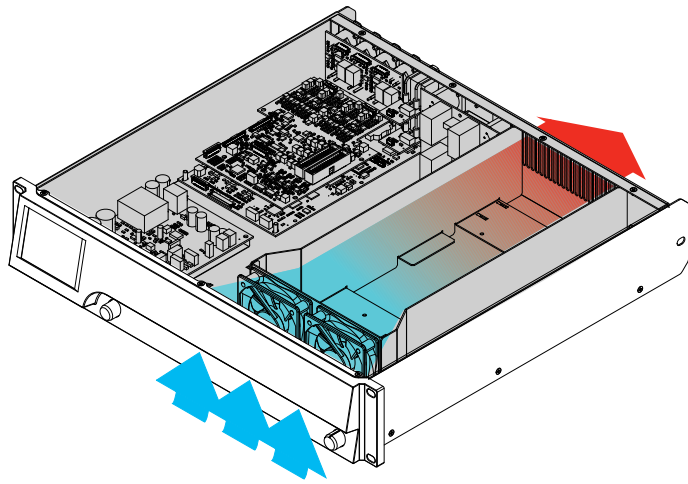
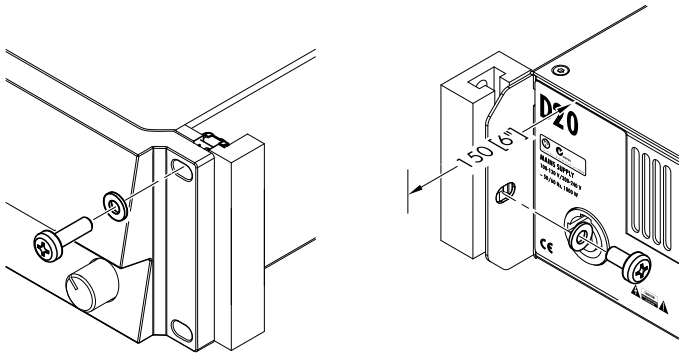

6.1. Rack mounting and cooling

Rack mounting

The D20 amplifier enclosure is designed to fit standard 19" equipment racks or cabinets.

When specifying a rack, be sure to allow extra depth (150 mm / 6" is usually sufficient) to accommodate the cables and connectors at the rear of the amplifier.

When mounting D20 amplifiers into a 19" rack, do not just rely on fixing and supporting the amplifiers by their front panels using appropriate rack mounting screws and U washers as shown in the graphic opposite. Provide additional support ...

- by fixing the rear-mounted rack ears using appropriate rack mounting screws and U washers as shown in the graphic opposite. This is particularly important when amplifiers are racked up for touring purposes.
- or using shelves fixed to the inner sides of the cabinet or rack.

Cooling

Thermal conditions are a vital factor to ensure operational safety of the power amplifiers. The D20 amplifier is equipped with two internal fans that draw cool air from the front into the housing and channel the warm air towards the back of the device.

- Please ensure that adequate cool airflow is provided.
- Do not block or cover the front panel air intake or the vents on the rear panel.
- If amplifiers are installed in sealed cabinets (e.g. in fixed installations), use additional fan modules with filters that can be easily replaced without opening the sealed cabinets.
- Do not combine D20 amplifiers with D6 or D12 amplifiers in one rack.
- Do not rack up D20 amplifiers together with other devices producing additional heat with opposing airflows.

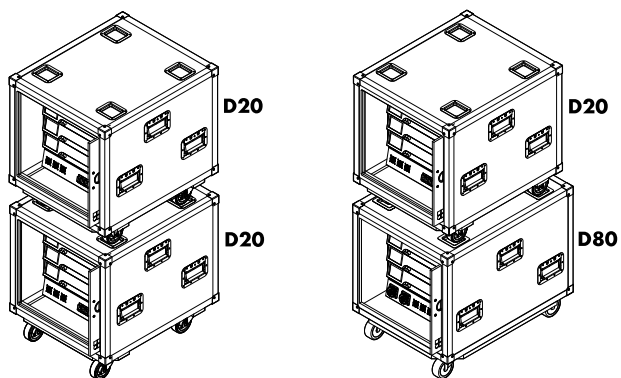
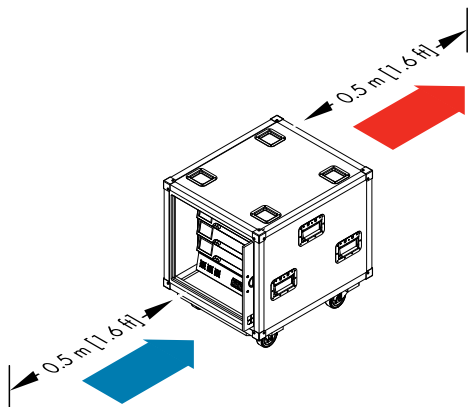

Touring rack assemblies

When using touring rack assemblies such as the d&b Z5560D20 Touring rack assembly or any other touring rack containing D20 amplifiers, make sure to provide sufficient space of 0.5 m (1.6 ft) at the front and rear of the touring rack to ensure adequate cooling airflow.

D20 Touring rack assemblies as well as D20 and D80 Touring racks can be stacked or positioned side by side.

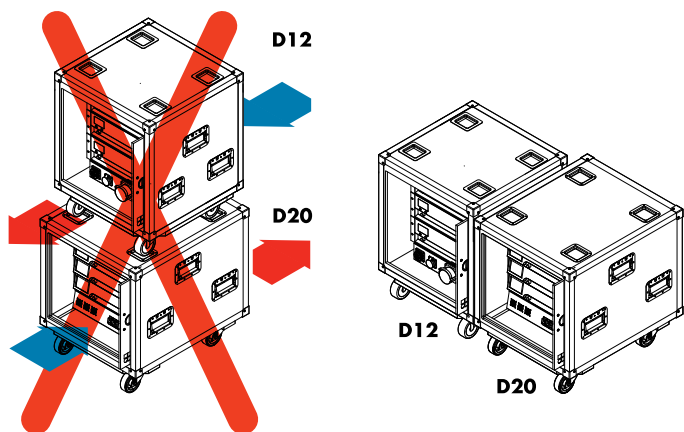
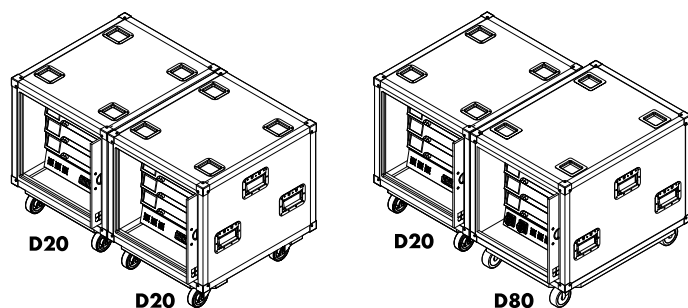

When combining the Z5330 D20 Touring rack assembly with the Z5310 D12 Touring rack assembly or any other rack assembly that produces an opposing airflow, observe the following restrictions:

- Do not stack D20 and D12 Touring racks or any other rack assemblies with opposing airflow.
- D20/D12 Touring rack assemblies can be positioned side by side.

6.2. Connections

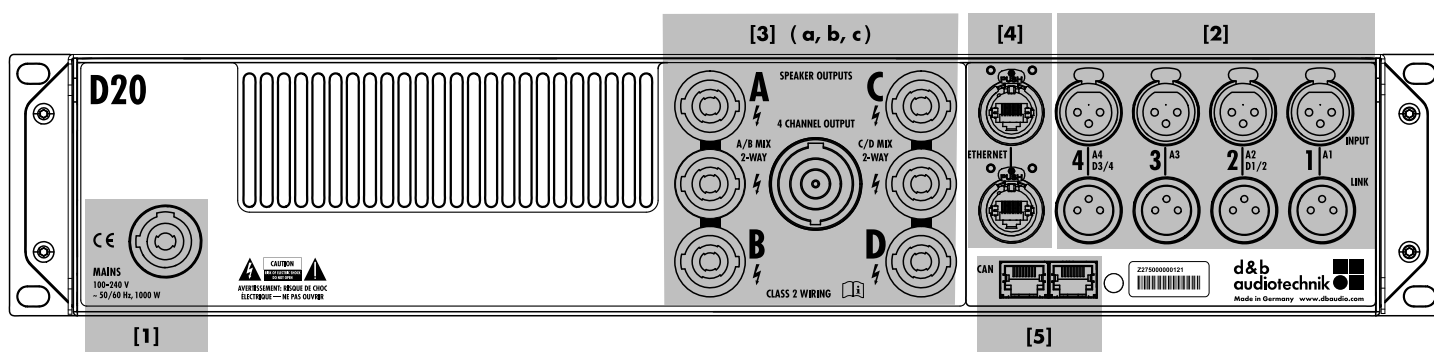

6.2.1. Mains connection



WARNING!

Potential risk of electric shock.

The device is a protective class 1 unit. A missing earth (ground) contact may cause dangerous voltages in the housing and controls and may lead to electric shock.

- Connect the unit to mains power supplies with protective earth only.
- If there is any sign of obvious damage to the power cord and/or mains connector, do not use the power cord and replace it before further use.
- Please ensure the mains connector is accessible at any time to disconnect the unit in case of malfunction or danger. If the mains plug is not readily accessible due to mounting in a 19" rack, then the mains plug for the entire rack must be readily accessible.
- Do not connect or disconnect the powerCON® mains connector under load or live.

Before connecting the device to mains voltage, check that the mains voltage and frequency correspond to the specifications on the rating label next to the mains connector socket on the rear panel of the unit.

Mains voltage range:

100 to 240 VAC, ~50/60 Hz, 1000 W.

A powerCON® mains connector socket [1] is fitted on the rear panel and an appropriate power cord [2] is supplied.

Number of devices per phase conductor

When full output power is required, it is strongly recommended to operate only **one** device per phase conductor.

For further details please refer to ⇒ Chapter 14.4. "Current/ power draw and thermal dissipation" on page 87.

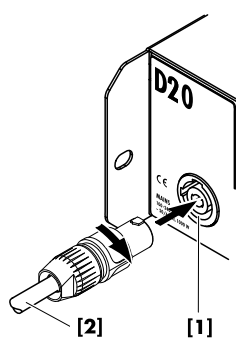
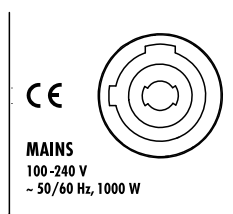

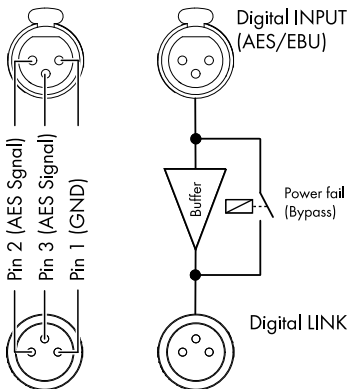
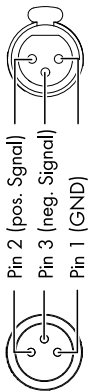
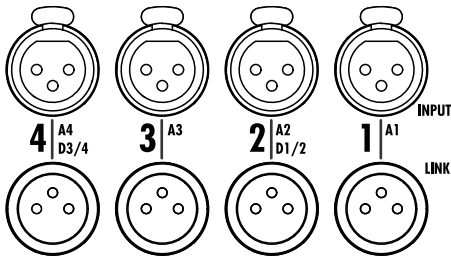

6.2.2. Audio INPUT and LINK connectors

All signal input and link output connectors 1-4 are located on the rear panel.

These can be configured as four analog inputs, two analog and two AES channels or four AES channels (Please refer to ⇒ Chapter 11.2. "Input" on page 36).

Each input channel can be routed to any of the output channels A to D (Please refer to ⇒ Chapter 12.6. "Input routing" on page 67).

Analog INPUT and LINK (A1 - A4)

A 3-pin female XLR input connector is provided for each channel. Wired in parallel is a 3-pin male XLR input link connector used to feed the input signal on to the next device in the signal chain.

Specifications

Pin assignment.....	1 = GND, 2 = pos., 3 = neg.
Input impedance.....	38 kOhms, electronically balanced
Common mode rejection (CMRR @ 100 Hz/10 kHz).....	> 60 / 50 dB
Maximum input level (balanced/unbalanced).....	+23 / 29 dBu
LINK analog (A1 - A4).....	3 pin XLR male
.....	parallel to input

Digital INPUT and LINK (D1/2 - D3/4)

The input connectors 2 (D1/2) and 4 (D3/4) can be configured as AES (AES3) inputs individually.

Note: When configuring the digital inputs, the remaining input and link output connectors 1 (A1) and/or 3 (A3) are disabled.

The corresponding digital LINK output (2/4) can be used to feed a refreshed input signal to the next device in the signal chain. The signal shape (the rising and falling edges of the signal) and level are refreshed using a latency free analog buffer amplifier.

A power fail relay is incorporated to prevent interruption of the signal chain should there be a power failure. In this situation, the digital input signal bypasses the analog buffer amplifier and is routed directly to the LINK output.

Specifications

Pin assignment.....	1 = GND, 2 = AES Signal, 3 = AES Signal
Input impedance.....	110 ohms, transformer balanced
Sampling.....	48 / 96 kHz / 2 Ch/n
Synchronization.....	Word-Sync: PLL-locked to source (slave mode)
LINK digital (Output).....	3-pin XLR male
.....	electronically balanced
.....	analog signal buffering (refresh)
.....	Power Fail Relay (Bypass)

6.2.3. Output connectors

SPEAKER OUTPUTS



WARNING!
Potential risk of electric shock.

The amplifier output pins can carry dangerous voltages.

- Only use isolated loudspeaker cables with correctly fitted connectors.
- Never connect an amplifier output pin to any other input or output connector pin or protective earth (ground).

The amplifier is supplied with four NL4 output connectors (A/B/C/D) one for each amplifier output channel.

In addition, two NL4 connectors are provided, one for each pair of amplifier output channels to allow either Mix TOP/SUB (A/B MIX, C/D MIX) or 2-Way Active (2-WAY) configurations.

All NL4 connector pins are hardwired and permanently driven using the following pin assignment.

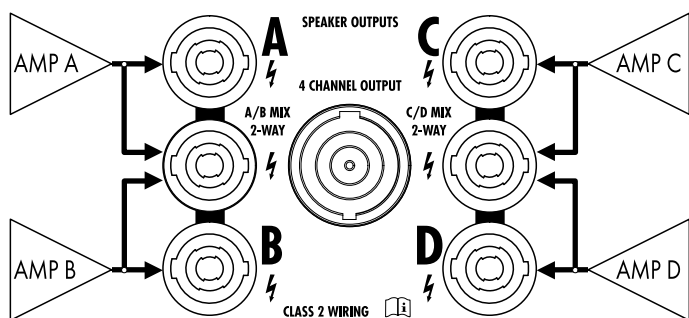

D20 SPEAKER OUTPUTS pin assignments

AMP	SPEAKER OUTPUTS					
	A	B	A/B	C	D	C/D
A	1+/1- 2+/2-		1+/1-			
B		1+/1- 2+/2-	2+/2-			
C				1+/1- 2+/2-		1+/1-
D					1+/1- 2+/2-	2+/2-

Note: A detailed description of the applicable output modes and how to configure the appropriate output mode is given in ⇒ Chapter 11.3.1. "Output mode" on page 46.

For further information regarding the applicable output modes for each loudspeaker system, please refer to the relevant loudspeaker manual.

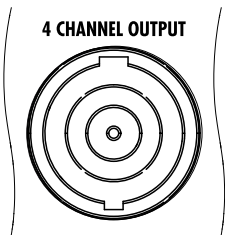

4 CHANNEL OUTPUT

NOTICE!

The 4 CHANNEL OUTPUT connector is only intended as an interface to a rack panel or to loudspeaker multicores and breakout adapters.

Do not connect any loudspeaker cabinets, neither passive nor active systems, to this connector, otherwise there is a risk of damaging the loudspeaker components or the amplifier.

The centered NL8 connector carries the output signals of all four amplifier channels with the following pin assignment:

1+/- = Channel A pos. / neg.	2+/- = Channel B pos. / neg.
3+/- = Channel C pos. / neg.	4+/- = Channel D pos. / neg.

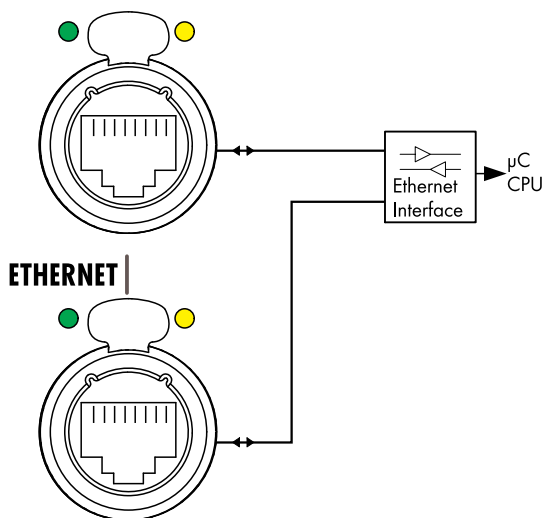

6.2.4. ETHERNET (Dual Ethernet port)

A Dual Ethernet port with a built-in 2-port Ethernet switch (10/100 Mbit/peer-to-peer) is provided enabling remote control via Ethernet and allows the following physical network topologies:

- Star topology
- **Recommended standard,**
- Daisy chain topology
- **For a maximum of three devices,**
- or a combination of both topologies.

Note: A detailed description of remote control via Ethernet is given in the technical information TI 310 (d&b code D5310.EN) which can be downloaded from the d&b website at www.dbaudio.com.

LED indicators

The two LED indicators above the respective connector in use indicate the following states:

- Green** Illuminates permanently when the device is connected to an active network and flashes as long as a data stream is transmitted.
- Yellow**
 - Is off when the speed is 10 Mbit.
 - Illuminates permanently when the speed is 100 Mbit.

Network topologies

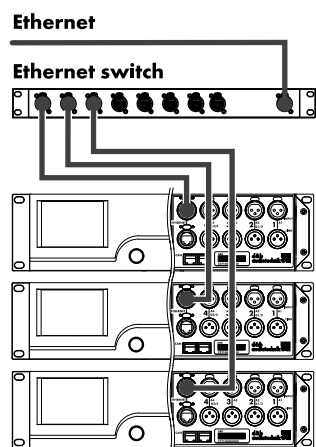

Star topology

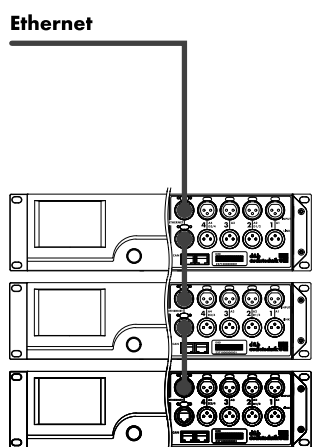

Daisy chain topology for a maximum of three devices

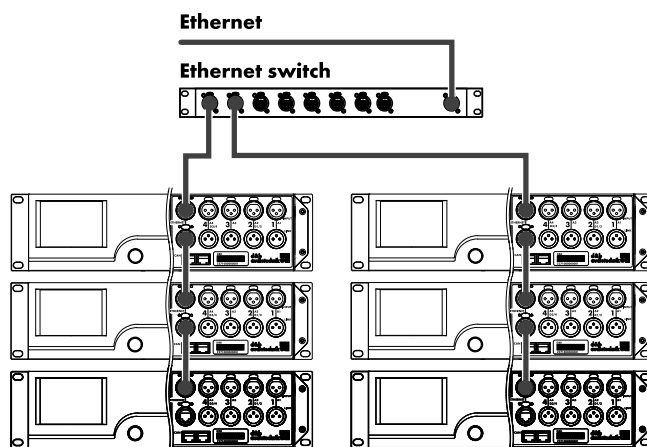

Combined topology

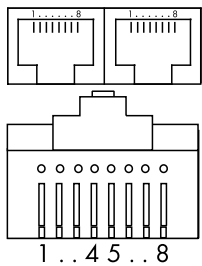
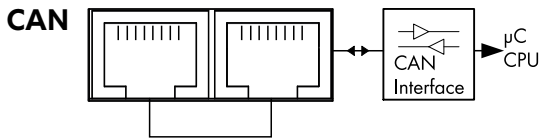

Pin 1: n.c.
 Pin 2: n.c.
 Pin 3: n.c.
Pin 4: CAN_H(igh) line
Pin 5: CAN_L(ow) line
 Pin 6: n.c.
 Pin 7: n.c.
 Pin 8: n.c.
Shield: CAN Ground (PE)

6.2.5. CAN (CAN-Bus)

The device is equipped with a 2-wire serial remote control interface carrying the CAN-Bus signals to enable remote control with the d&b R60 USB to CAN or R70 Ethernet to CAN interfaces.

Note: A detailed description of remote control via the d&b Remote network (CAN-Bus) is given in the technical information TI 312 (d&b code D5312.EN) which can be downloaded from the d&b website at www.dbaudio.com.

All pins of both connectors are wired in parallel allowing either to be used as input or output (daisy chaining) or for terminating the CAN-Bus network.

Pin assignment

The pin assignments of both, the RJ 45 sockets and the cable connectors, are shown in the graphic opposite.

Note: The connections for the CAN-Bus are referenced to common ground. The "CAN Ground" is routed **via the cable shielding** and is hardwired to PE.

Within the CAN-Bus network, shielded cables and shielded RJ 45 connectors (metal housing) must be used while the cable shielding must be connected to both sides.

CAN network topologies

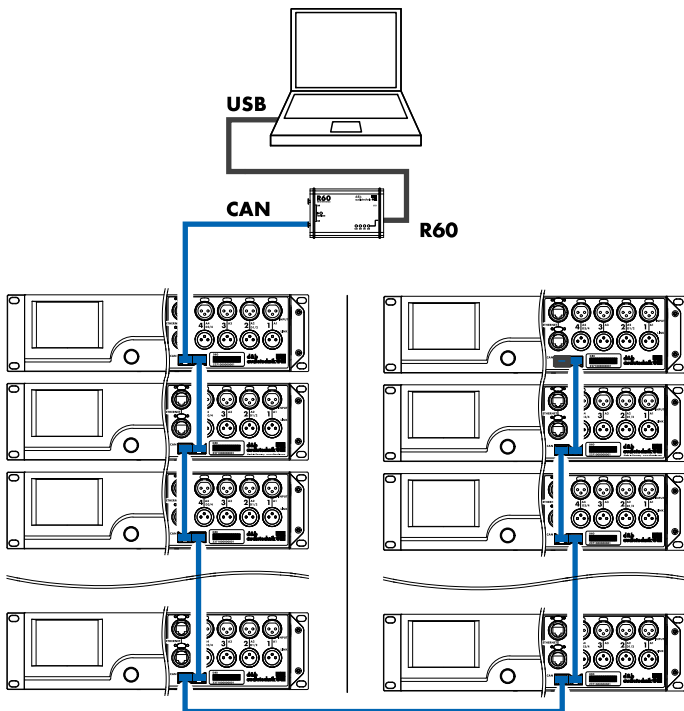

Daisy chain topology
 With R60 USB to CAN interface

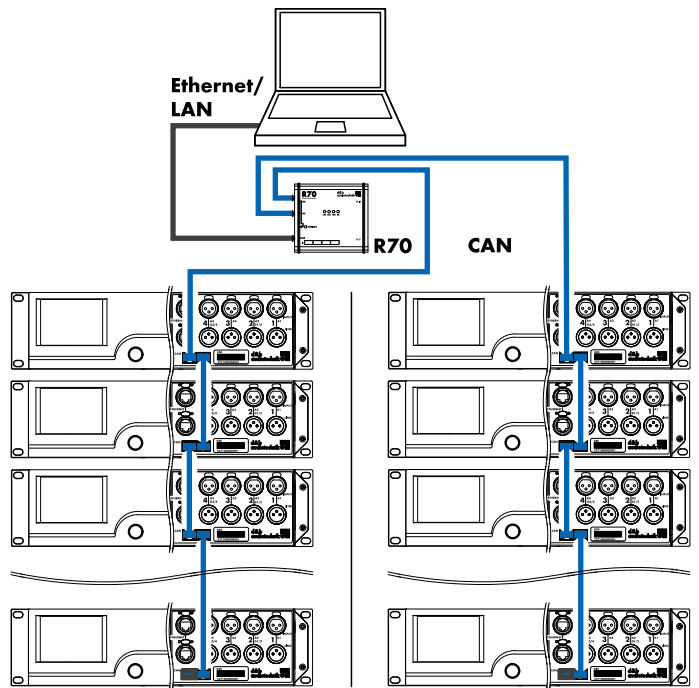

Combined topology
 With R70 Ethernet to CAN interface

6.3. Controls and indicators

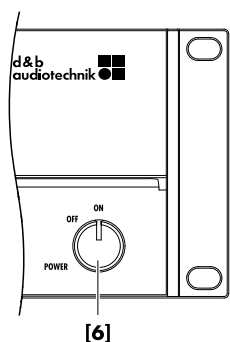
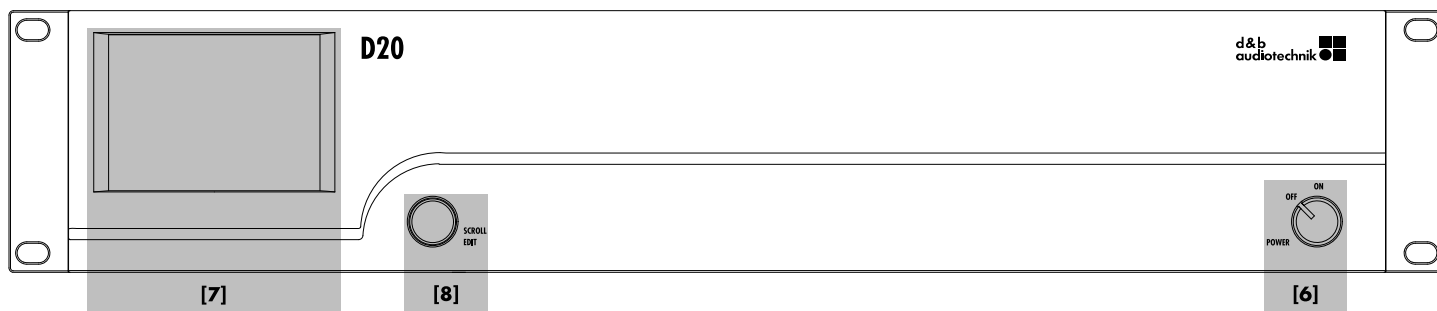

6.3.1. Mains power switch

The on/off rotary switch [6] is located on the bottom right of the front panel.

- OFF** Mains isolation is not provided. The internal power supplies are off but stay connected to the mains.
- ON** The unit is switched on and ready for operation.

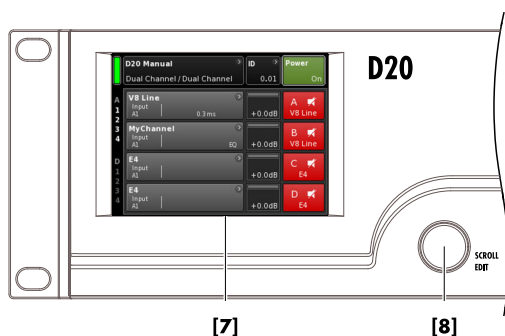

6.3.2. Display - User interface

Operation, configuration and status viewing are all performed via the Display ⇒ User interface.

The user interface consists of a 3.5" TFT color touch screen [7] with a resolution of 320 x 240 pixels and an additional digital rotary encoder [8].

The resistive touch screen responds to pressure and therefore can be operated by a fingertip, even when wearing gloves, or by an appropriate stylus tip (pen).

NOTICE!

The touch panel utilizes a thin flexible sheet that may be damaged by sharp objects or heavy treatment.

Due to the wide range of functions the user interface is described separately in more detail in ⇒ Chapter 7. "User interface" on page 25.

However, both the Standby and Mute functions of the D20 are described in the following two sections.



6.3.3. Standby mode

To switch the device to Standby mode ... :

1. Tap the «Power» button on the top right of the Home screen.
 - ⇒ A dialog appears allowing you to either select the Back button (⌂ - cancel), «Mute all» or «Standby».

2. Select «Standby».
 - ⇒ When the device is in Standby mode, both the «Power» button on the right and the green Power on indicator on the left are switched off. In addition, on the «Device view» button, Standby flashes alternating with the Device name.
 - In Standby mode, the user interface of the device is still operable.

3. To repower the device, tap the «Power» button.
 - ⇒ Startup time from Standby state is <1 sec.

The operating state (Standby mode) is stored when the «Power» button is set to "Off" and is restored when the «Power» button is set back to "On" again.

In Standby mode, the main power supply and the power amplifiers are switched off to save energy and the loudspeaker outputs are electronically isolated. The display and controls remain active to allow repowering of the device by remote control or by tapping the «Power» button on the Home screen.

Note: When the device is set to Standby (or the mains power is switched off), the movement of the loudspeaker cones in the connected cabinets is no longer damped by the power amplifier output. This removal of the damping makes them susceptible to excitation by other loudspeakers in the surroundings. Audible resonances may occur, and even absorption of low frequency sound energy as the undamped loudspeakers act like a "bass trap".

To permanently mute single subwoofer cabinets while others are operated at the same time it is therefore preferable to use the Mute function instead of Standby. However, the Standby mode can be useful with mid/high systems as it removes any residual noise from the system.

6.3.4. Mute functions

The D20 provides two mute functions:

- Individual mute buttons for each channel or pair of channels
⇒ Channel mute,
- and a master mute function ⇒ «Mute all».

Note: The device stores the setting of the mute buttons when the mains power is switched off or disconnected. When the unit is switched on or reconnected, the mute status will be recalled.

Channel mute

- ⇒ To mute or unmute a single channel or a pair of channels, simply tap the respective Channel mute button.
- ⇒ The Channel mute button displays the mute status of the relevant channel or pair of channels and the loudspeaker setup loaded.

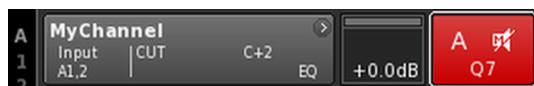
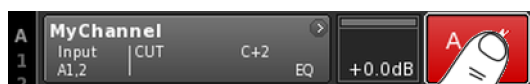

Channel muted

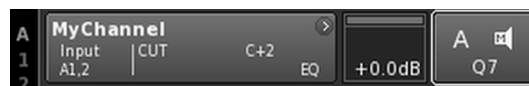

Channel unmuted



Master mute («Mute all»)

1. To mute all channels simultaneously, tap the «Power» button on the top right of the Home screen.
 - ⇒ A dialog appears allowing you to either select the Back button (⌫ - cancel), «Mute all» or «Standby».
2. Select «Mute all».
 - ⇒ To unmute the channels, use the individual Channel mute buttons.

7. User interface

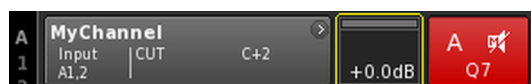
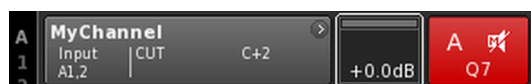
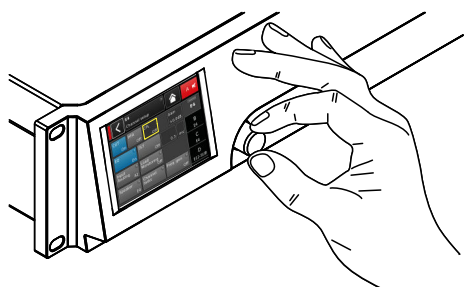
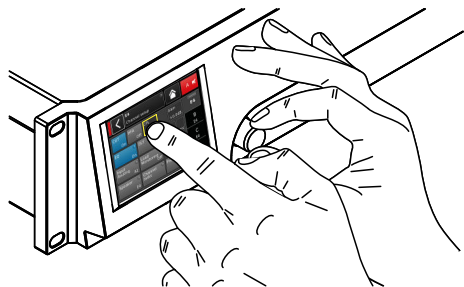

7.1. Operating concept

The operating concept allows different methods of interaction and configuration.

Touch screen in combination with the rotary encoder

This method may preferably be used to define values of input fields such as Gain settings, CPL, Delay or EQ settings.

- Select menus, menu items and/or function elements by tapping the relevant item.
- Enter/edit values by turning the encoder.
- Confirm entered/changed values by tapping the respective item or confirmation button («OK») or pushing the encoder.

Rotary encoder only

This method is mainly intended for users who are familiar with the user interfaces of other d&b amplifiers.

- Select menus, menu items and/or function elements by turning the encoder to move the Position cursor to the relevant item.
- Access the selected item or function element by pushing the encoder.
- Enter/edit values by turning the encoder.
- Confirm entered/changed values or leave Edit mode by pushing the encoder.

Cursor conventions

The graphical user interface features two types of cursors, the Position and the Edit cursors.

Position cursor

The Position cursor marks the selected Menu item by a white frame. Depending on the type of screen item, the Position cursor allows you to either activate a function, navigate through the menu or enter Edit mode ⇒ Edit cursor.



Edit cursor

In Edit mode, the Edit cursor is marked by a yellow frame. Turning the encoder to the right (clockwise) increases the current value, turning the encoder to the left (counterclockwise) decreases it.



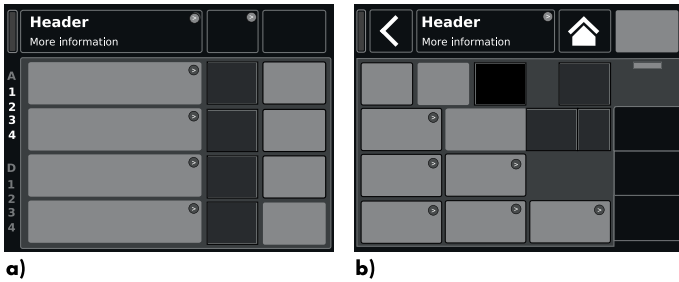

To leave Edit mode press the encoder or simply tap the respective Menu item again. The color of the frame will change from yellow back to white again ⇒ Position cursor.



a)
Basic screen layout
a) Home screen
b) Device and Channel setup screens

7.2. Screen layout and conventions

The screen layout is split into two main parts, the Header and the Data sections.

Header The Header (Headline) indicates which screen is currently selected. In the Device and Channel setup screens, the Header allows direct access to the previous screen (Back button - ) or to the Home screen (Home button - .

Data Except for the Home screen, the Data sections of the Channel and Device setup screens are structured in tabs on the right hand side of the screen. The tabbed structure of the screens allows you to directly access the desired subscreens.

7.3. Screen items and views

This section describes the different menu items, views and function elements characterizing the user interface of the D20.

7.3.1. Function buttons

Properties:

- The top left of the button shows the function name while the bottom right shows the status of the function. In addition, the status is also indicated by colors.
- The function is activated by tapping the button on screen or pushing the encoder.
- Functions buttons can also be combined with navigation buttons.



7.3.2. Navigation buttons

Properties:

- The top right of the button shows the navigation symbol (.
- Open the related subscreen by tapping the button on screen or pushing the encoder.



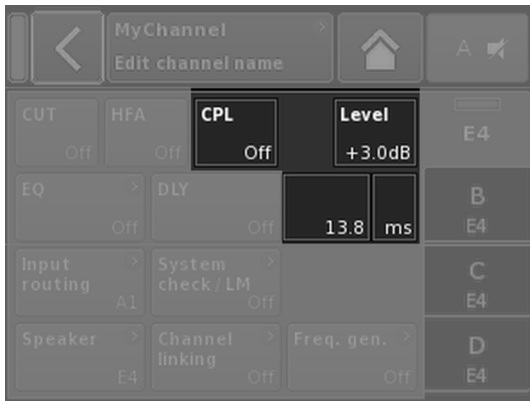

7.3.3. Input fields

Properties:

- The top left of the button shows the field name while the bottom right shows the value. The value can be edited.
- Select the value by tapping the button on screen or pushing the encoder.
- Edit the value by turning the encoder.

Note: The set value will be applied directly.



7.3.4. Input masks

Properties:

- Appears automatically anytime you need to enter data to define a particular function. The input mask provides you with an alphanumeric or numeric keypad to enter, for example, a device name or a channel name (alphanumeric keypad) or an IP address (numeric keypad).
- Selection and editing is performed using the touch screen or turning and pushing the encoder.

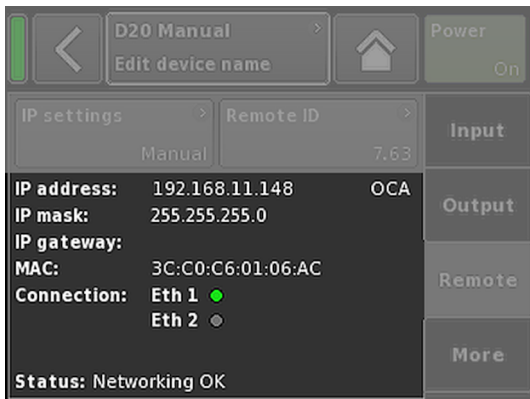

7.3.5. Information fields

Properties:

Non-selectable/non-editable field for information purposes only.

8. Home screen



From the Home screen, the menu structure of the operating software is divided into two main axes, the Device setup and the Channel setup. The navigation buttons allow for direct vertical access to the specific submenus while the tab structure on the right side of each submenu provides a clear horizontal order.

In addition, the Home screen gives direct access to the Remote subsection.

The Home screen can be accessed from any screen or menu at any level using the Home button (🏠).

Home screen access chart

Hierarchy level

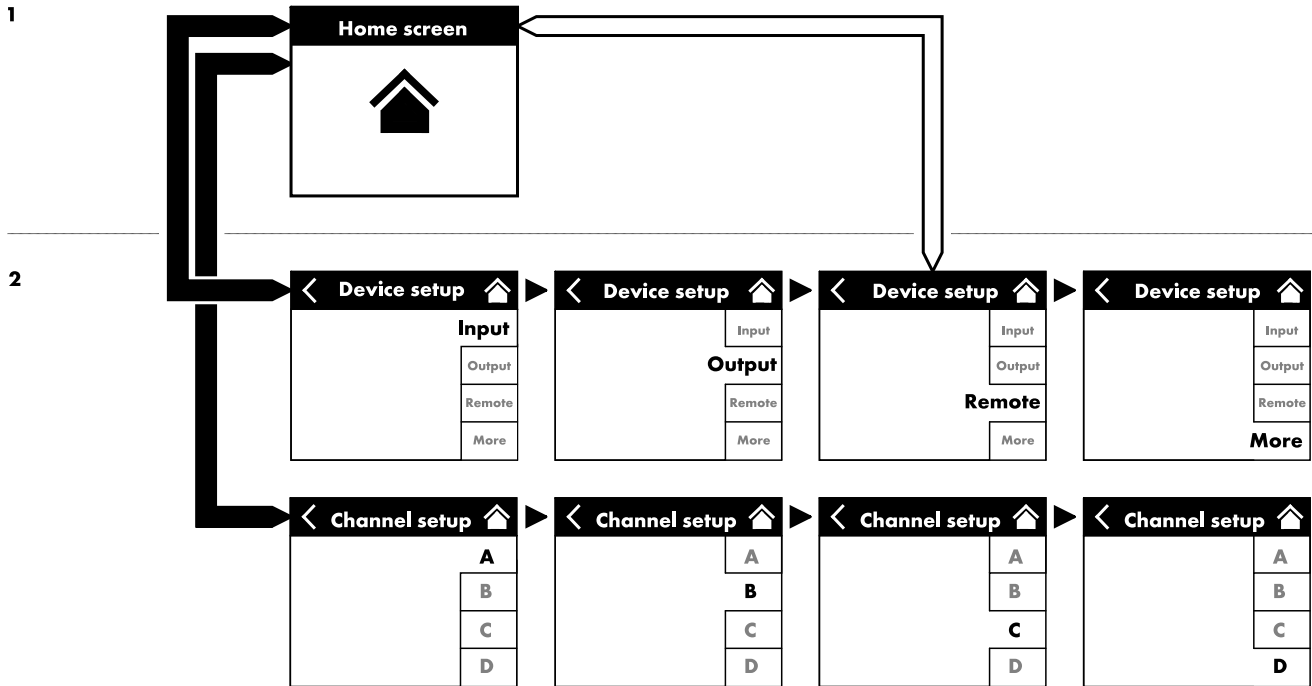



8.1. Header area - Device

(from left to right):

Power on indicator

Yellow Indicates the start up phase of the power supply.

Green Indicates that the unit is switched on.

Red Indicates a device error.

Device view button

The device name and the output mode are displayed. This button provides direct access to the Device setup screen.

ID

The Remote «ID» is displayed. This navigation button also provides direct access to the Remote subscreen.

Power button

The «Power» button provides the following functions:

◀ Cancel the sequence.

Mute all Master mute.
To unmute the channels, use the individual Channel mute buttons.

Standby In Standby mode the device idles drawing minimal power consumption. Only the most essential functions are provided. The screen and network remain functional.

8.2. Data area - Channel strip(s)

The data area features the actual channel strips starting with the input connector and then following the real signal flow from left to right. All vital information is displayed. This includes:

- Input signal present (ISP)
- Input routing
- Channel configuration,
- Controller output signal (OSP)
- Channel mute buttons and status.
- Error messages

9. Channel strip

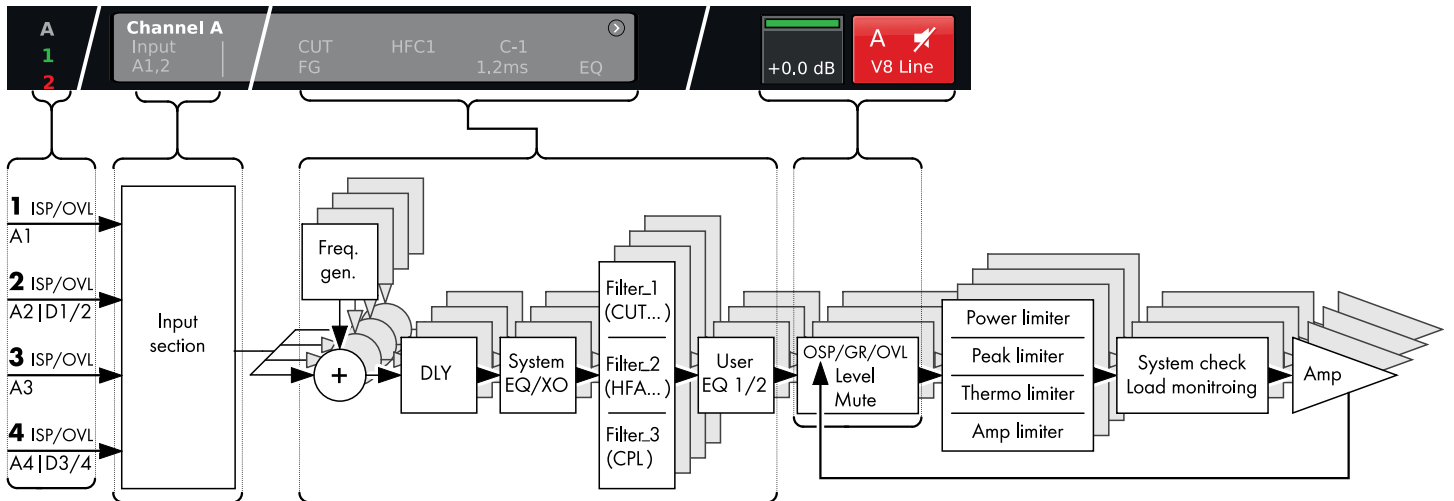

D20 Channel strip block diagram (signal chain)

The channel strip follows the actual signal chain from left to right:

ISP/OVL

Indicates the following states for both, the analog (**A**) and the digital (**D**) signal inputs:

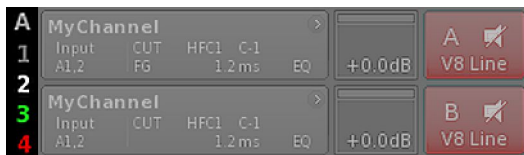

Gray

The relevant channel is not available.

White

The relevant channel is available and an input signal is not present or below -30 dBu.

Green

ISP (Input Signal Present): Illuminates when the analog input signal exceeds -30 dBu or when the digital input is locked to 48 or 96 kHz and the signal exceeds -57 dBFS.

Red

OVL (Overload): Illuminates when the analog input signal exceeds 25 dBu or when the digital input signal exceeds -2 dBFS.

Channel view

The Channel view button displays the Channel name. If no Channel name has been entered, the loudspeaker setup which is currently loaded is displayed. In addition, the activated function elements are indicated. The button provides direct access to the \Rightarrow Channel setup screen.

Level

The Level input field allows direct setting of the amplifier's relative input sensitivity in the range of -57.5 dB to $+6$ dB in steps of 0.5 dB.

In addition, the following indicators are available:



ISP/OSP/GR/OVL

Grey No signal present.

Dark green **ISP: Channel Input Signal Present.**
 Similar to the analog and digital input indicators, this indicator illuminates when the DSP receives an analog input signal that exceeds -30 dBu or when the digital input is locked to 48 or 96 kHz and the signal exceeds -57 dBFS.

Bright green **OSP: Power amplifier Output Signal Present.**
 Provided the respective channel is not muted, this indicator illuminates when the output voltage of the power amplifier exceeds $4.75 V_{RMS}$.

Yellow **GR (Gain Reduction):**
 Illuminates when one limiter reduces the signal by a predefined level ($GR \geq 3$ dB).

Red **OVL (Overload):**
 Illuminates when ...:

- any signal within the channel exceeds -2 dBFS,
- DSP suffers from an internal EQ filter overflow,
- any limiter causes a gain reduction of 12 dB or more,
- the output signal is limited to prevent distortion due to output peak current overload.



Channel muted



Channel mute

- ⇒ To mute or unmute a single channel or a pair of channels, simply tap the respective Channel mute button.
- ⇒ The Channel mute button displays the mute status of the relevant channel or pair of channels and the loudspeaker setup loaded.

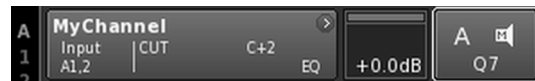

Channel unmuted

A channel error is indicated on the Channel mute button by an exclamation mark ⇒ .

A corresponding error message is issued on the Channel view button.

10. Basic settings - Quick reference

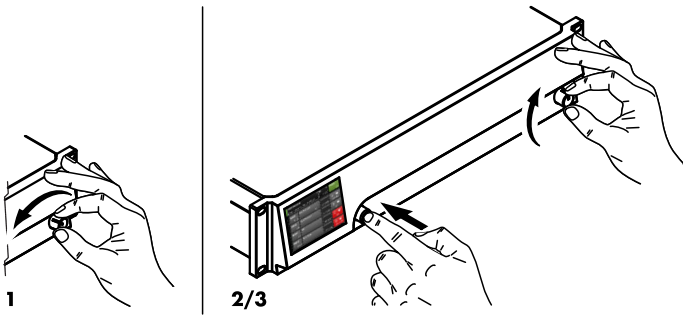

Due to the vast functional range and possible settings of the D20 amplifier, this section is intended as a quick reference to provide you with a systematic procedure for defining the basic settings of the amplifier.

It is advisable to start with the device settings followed by the individual channel settings.

System reset

Before starting to define the basic settings, perform a system reset.

1. Switch off the device.
2. Press and hold the encoder and repower the device.
⇒ Long confirmation beep.
3. Release the encoder and briefly press the encoder again within 2 sec.
⇒ Short confirmation beep.
The device will boot up and will switch to the Home screen. A corresponding message will be issued:

All device settings have been cleared

1. Device setup

- ⇒ On the Home screen, tap the Device view button.
- ⇒ This will enter the Device setup subscreen with the «Input» tab being active.



2. Input (Input mode / Input routing)

- ⇒ Define your Input mode and Input routing settings for all channels correspondingly.

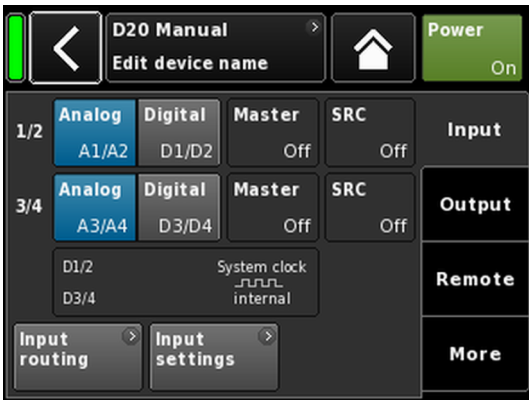

Note: A detailed description of the Input routing is given in the reference chapter of the Channel setup ⇒ Chapter 12.6. "Input routing" on page 67.

A detailed description of the Input mode is given in the reference chapter ⇒ Chapter 11.2. "Input" on page 36.

3. Output (Output mode)

- ⇒ Tap the «Output» tab and define your desired output mode settings for each pair of amplifier channels correspondingly.

Note: A detailed description of the available output modes is given in the reference chapter ⇒ Chapter 11.3. "Output" on page 45

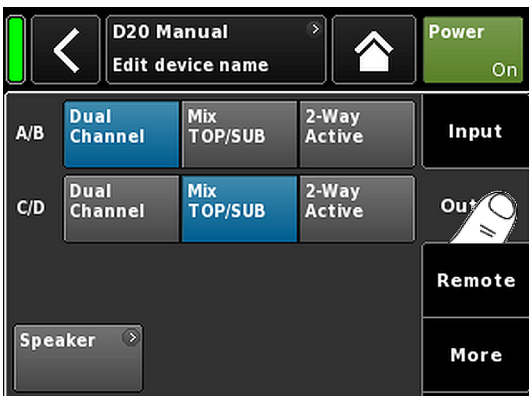



Speaker

1. On the bottom left of the «Output» tab, select the «Speaker» navigation button to enter the Speaker setup subscreen.
2. Choose the desired speaker setups for all channels and confirm each selected setup by tapping the «OK» button right next to the «Speaker» selection field.
3. Define the LoadMatch settings, if applicable and desired, correspondingly.
4. After defining all settings, exit the subscreen by tapping the Home button (🏠).

Note: A detailed description of the Speaker setup and LoadMatch settings is given in the reference chapter ⇒ Chapter 12.8. "Speaker" on page 71.

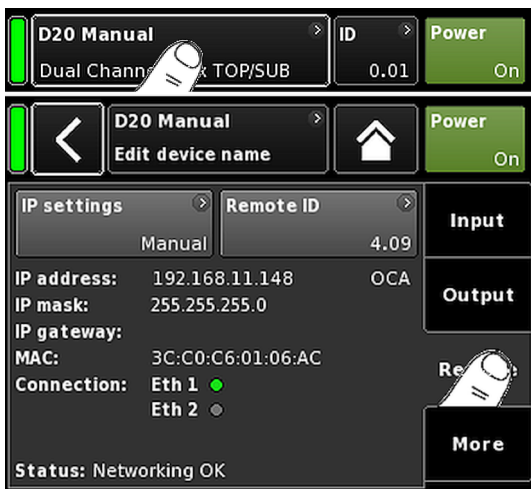

4. Remote

1. On the Home screen, tap the Device view button to enter the Device setup menu.
2. Tap the «Remote» tab and define your desired Remote settings correspondingly.

Note: A detailed description of the remote settings is given in the reference chapter ⇒ Chapter 11.4. "Remote" on page 49.

As all the configurations and settings mentioned above can also be defined remotely, it depends on how you wish to proceed whether defining the Remote settings is the last or the first step when configuring your basic settings.

After defining all settings, exit the subscreen by tapping the Home button (🏠) and carry on with the individual channel settings.

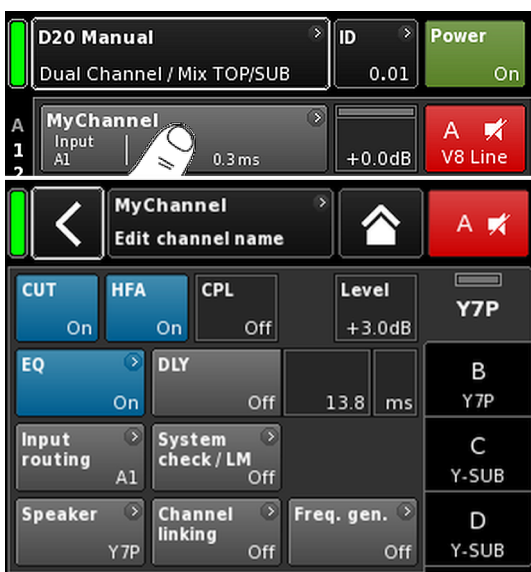

5. Channel setup

1. On the Home screen, tap the Channel view button of the first channel (A) or pair of channels (A/B) to enter the Channel setup.
2. Define your individual channel settings such as CUT, HFA, CPL, Level, DLY or EQ for all channels correspondingly.
3. After defining all settings, exit the subscreen by tapping the Home button (🏠).

Note: A detailed description of the Input routing is given in the reference chapter ⇒ Chapter 12.6. "Input routing" on page 67.

A detailed description of the Input mode is given in the reference chapter ⇒ Chapter 11.2. "Input" on page 36.

11. Device setup

Device setup access chart

Hierarchy level

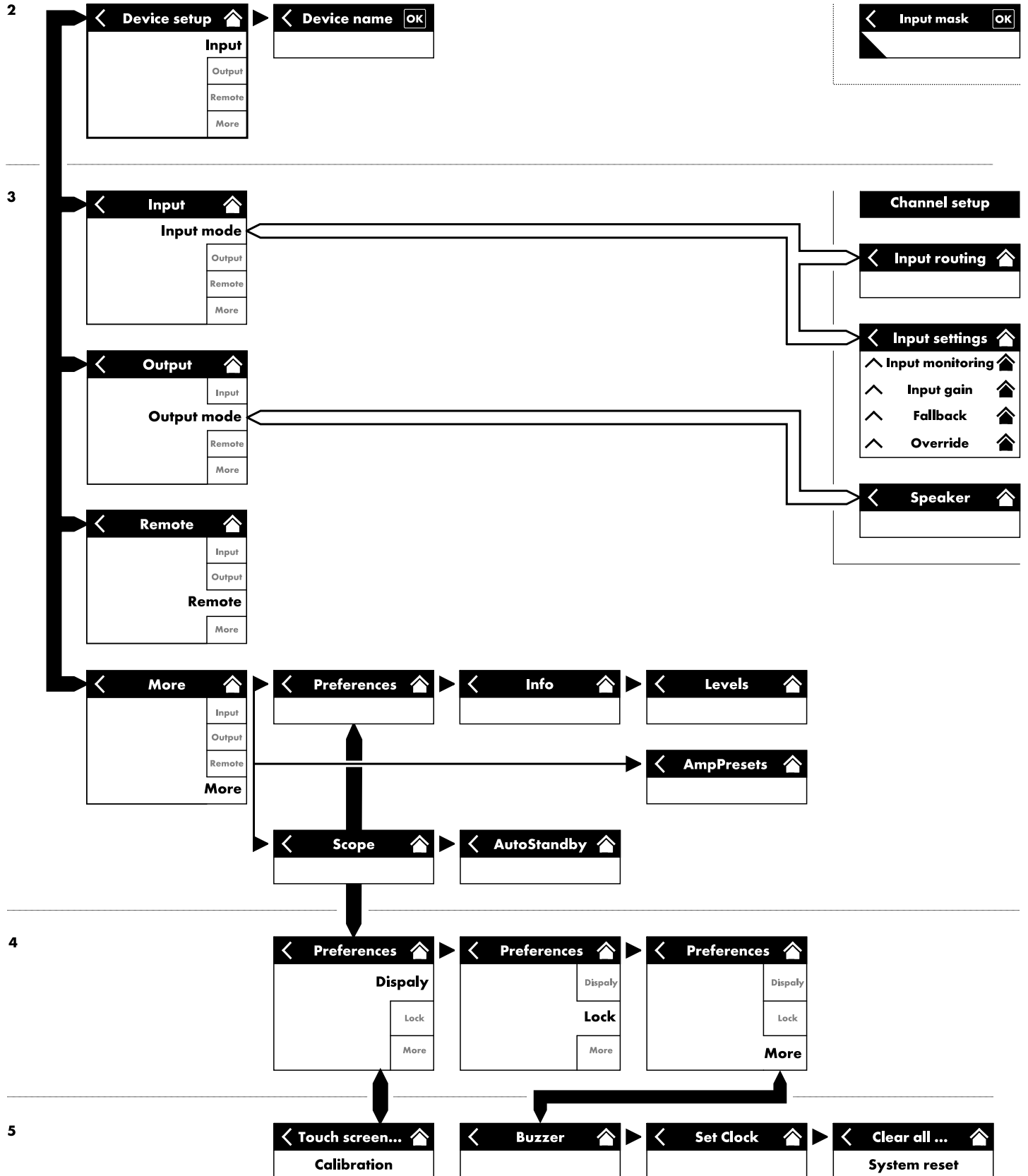

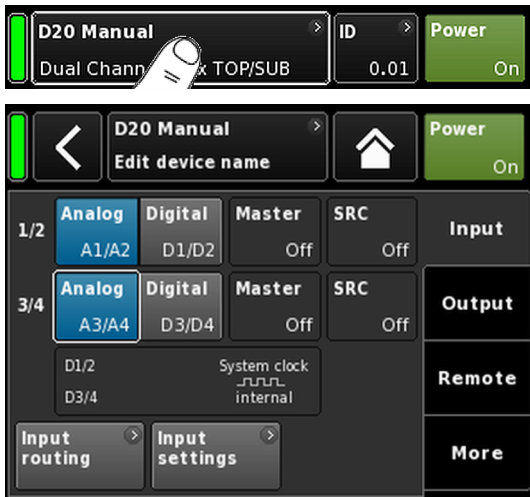

From the Home screen, selecting the Device view button opens the Device setup screen with the «Input» tab being active.

The Device setup screen follows the same layout structure as described above and is split into the Header and the Data sections.

Using the tabbed structure of the Device setup screen provides direct access to the desired subscreens.



11.1. Device name

Selecting the centered Information field button («Edit device name») in the header of the device setup screen enables you to enter or edit the device name (maximum length 15 characters).

The input mask which appears allows either lower-case or upper-case characters by toggling the corresponding button («abc») on the bottom left.

Wrong entries can be corrected by tapping the Erase button (⌫) on the bottom right.

Tapping «OK» on the top right confirms the entry, closes the input mask and switches back to the Device setup screen.

Tapping the Back button (⏪) on the top left cancels any entry and switches back to the Device setup screen keeping the previous entry.

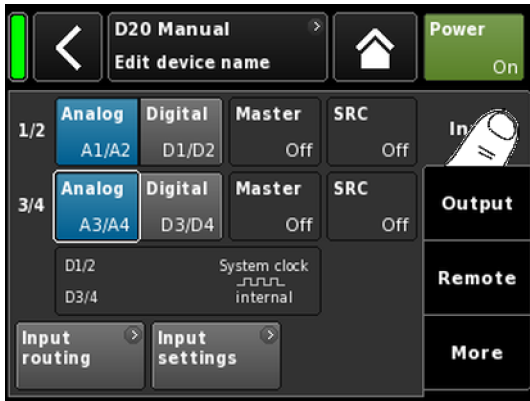

11.2. Input

Selecting the «Input» tab offers the complete input management in one place.

It allows you to configure the input mode for the input connector pairs 1/2 and 3/4 independently to accept either analog or digital input signals.

The operating modes of the corresponding link output connectors 2 and 4 depend on the set input mode.

The tab also provides access to the ⇒ «Input routing» and ⇒ «Input settings» menus which enable you to configure dedicated input settings, such as:

- ⇒ Input monitoring (Mon)
- ⇒ Input gain (Gain)
- ⇒ Fallback
- ⇒ Override

11.2.1. Input mode

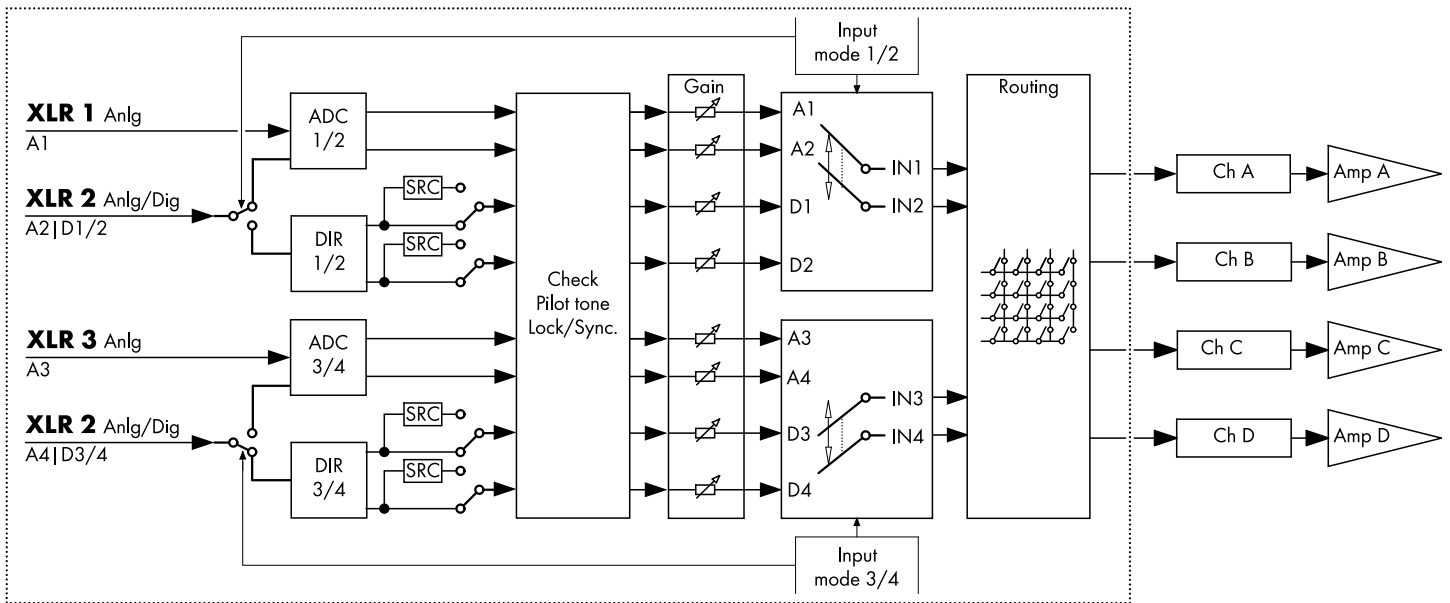

Input mode block diagram

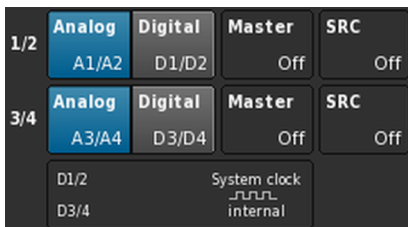

Analog/Analog

Both input connector pairs 1/2 and 3/4 are set to «Analog», an analog audio signal is accepted by inputs 1, 2, 3 and 4.

Digital/Digital

NOTICE!

When both input pairs are set to «Digital» and locking to the sync source is not possible, none of the inputs will receive any audio signal.

If two digital signals are used at the same time, these signals must be completely synchronous (i.e. must have the same synchronized sampling rate).



Both input connector pairs 1/2 and 3/4 are set to «Digital», a 2-channel digital audio signal is accepted by inputs 2 and 4 respectively.

The input connectors 1 and 3 are not available.

Locking to either 48 or 96 kHz is indicated below (System clock). In this case, the sync source is input 2.

When both input pairs are set to «Digital», either of them can be selected as sync source.

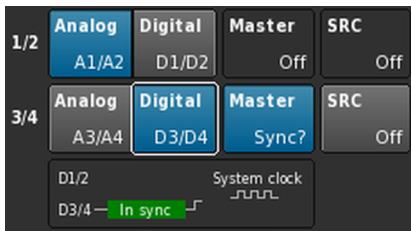

Mixed

Input connector pair 1/2 is set to «Analog», an analog 2-channel audio signal is accepted by inputs 1 and 2.

Input connector pair 3/4 is set to «Digital», a digital 2-channel audio signal is accepted by input 4.

A3 by input 3 is not available.

Locking to either 48 or 96 kHz is indicated below (System clock). In this case, the sync source is input 4.

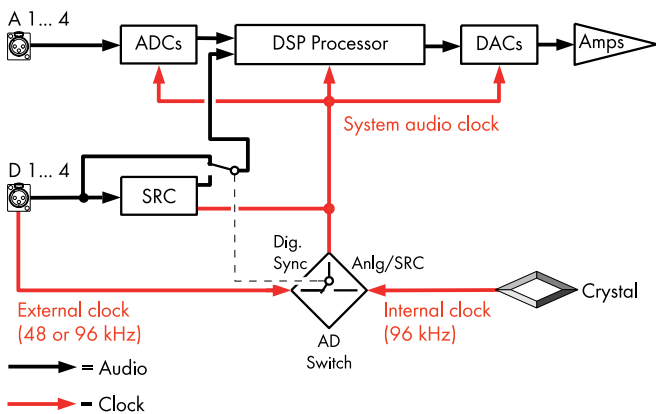

System clocking

To keep latency as short as possible, the system does not utilize non-clocked (asynchronous) Sample Rate Converters (SRC).

The clock of the digital audio system is derived from an internal crystal oscillator with a sampling rate of 96 kHz. Alternatively, the clock can be derived from a signal fed to the digital inputs. The sampling rate of this signal must also be 96 kHz. The derived clock is PLL filtered to avoid possible jitter.

It is also possible to use a signal with a sampling rate of 48 kHz as it is in even proportion to the required 96 kHz. In this case, the system detects the sampling rate and automatically doubles it using a synchronous sampling rate doubler to achieve the required 96 kHz. The required filtering is calculated using linear phase FIR filters.

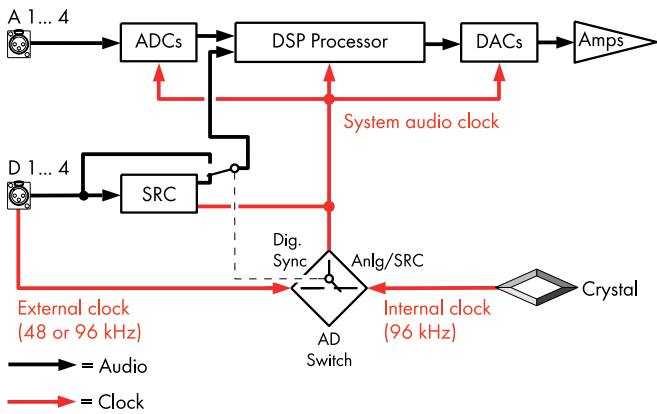

SRC

If the digital inputs are fed from two different sources with sampling rates other than 48/96 kHz, a Sample Rate Converter («SRC») can be enabled.

Note: Please note that this will result in a slightly increased basic latency $\Rightarrow \leq 1$ ms.

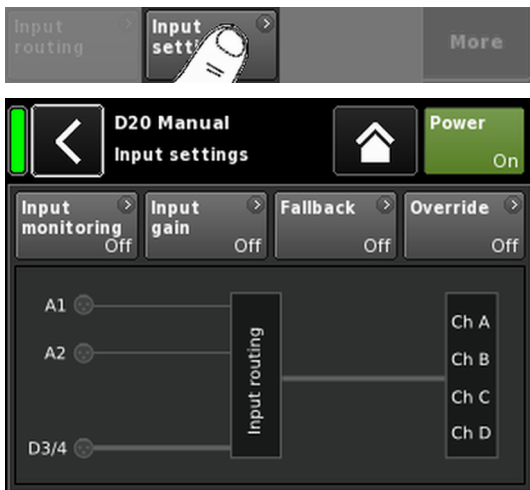

11.2.2. Input settings

Selecting «Input settings» at the bottom of the «Input» tab opens the corresponding subscreen.

The «Input settings» screen provides access to the following input related functions:

- Input monitoring (Mon)
- Input gain (Gain)
- Fallback
- Override

The on/off status of each function is indicated by change in color of the respective button from grey to blue or vice versa.

Below these buttons, there is a graphical presentation of the actual input routing.

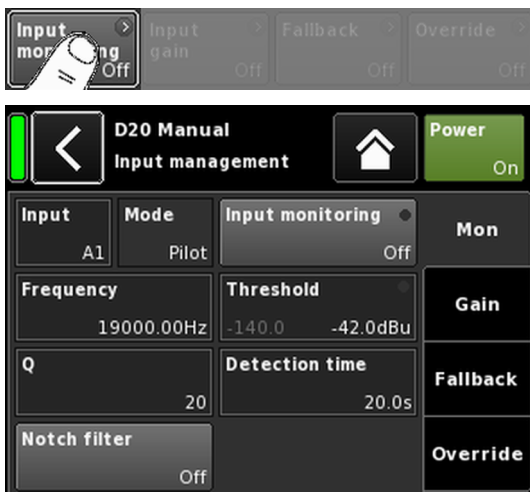

11.2.2.1. Input monitoring

Selecting «Input monitoring» from the «Input settings» menu opens the corresponding subscreen.

The d&b "Input monitoring" function enables the amplifier to monitor all signals, either from analog and/or digital signal sources, fed to the respective input (\Rightarrow «Input»). If one or several signals fail, a corresponding error can be generated and reported to the user or system.

At the signal source, an additional external pilot signal (sine wave signal) is added (summed) to the source signal.

Within the amplifier, this pilot signal can be detected (\Rightarrow «Mode» \Rightarrow «Pilot») using an adjustable bandpass filter (\Rightarrow «Frequency»).

As long as the pilot signal is permanently and safely present within the given pilot band, this is an indication that the incoming signal path is faultless.

For this purpose, the amplifier determines the level of the pilot signal within the pilot band. The result is then compared with an adjustable reference threshold set by the user (\Rightarrow «Threshold»). If the level of the pilot signal falls below the reference threshold, a time-related error can be generated (\Rightarrow «Detection time»).

The pilot signal can be removed from the source signal (program signal) at any time using a notch filter (⇒ «Notch filter»).

When the function is used with digital inputs, it is also possible to detect whether the device has locked to the digital source signal or not (⇒ «Mode» ⇒ «Lock»).

Finally, the Input monitoring mode «DS data» permanently monitors the meta data information sent by a d&b DS-Series device and the «Fallback» function can be triggered if the Dante channel is not available on either the Primary or the Secondary network.

Input monitoring settings

Input Input selector (A1 - A4, D1 - D4).

Mode Depending on the selected input (analog or digital), the following mode settings are available:

Input	Mode		
	Pilot	Lock	DS data
A1 - A4	Yes	No	No
D1 - D4	Yes	Yes	Yes

Input monitoring

Master On/Off switch with error LED indicator.

The On/Off status as well as the error status are also displayed on the «Input settings» screen.

The error status is also indicated on the «Home» screen. A corresponding message (Input monitoring fault) will be issued.

Frequency

Center frequency of the pilot band, adjustable from 5 Hz to 24 kHz in 1 Hz or 0.01 Hz increments. The chosen increment is shown in light grey at the top right of the field.

When you select this field for the first time, the increment is set to 1 Hz.

To toggle between 1 Hz or 0.01 Hz increments, simply click the field again.

To confirm the chosen frequency, click any other field or the blank space next to the notch filter button.

Note: The set frequency also applies to the notch filter.

Threshold

Detection threshold for an external pilot signal of the set frequency, adjustable in the range from -117 dBu to +21 dBu in 1 dB increments.

At the bottom left of this field, the actual level is displayed in light grey while the set threshold is displayed at the bottom right.

Once a pilot signal is detected, the corresponding LED indicator at the top right illuminates green.



Quality

The Q of the notch filter, adjustable from 4 to 42 in increments of 1. The center frequency is fully attenuated ($\Rightarrow -\infty$ dB).

Detection time

The maximum time interval that is allowed for an interruption of the monitored pilot signal or digital clock (Lock) without an error message being generated (0.1 ... 99.9 sec. in 0.1 sec. increments).

Notch filter

Notch filter to remove the pilot signal from the program signal. However, if activated, the notch filter remains active even if Input monitoring is set to Off.

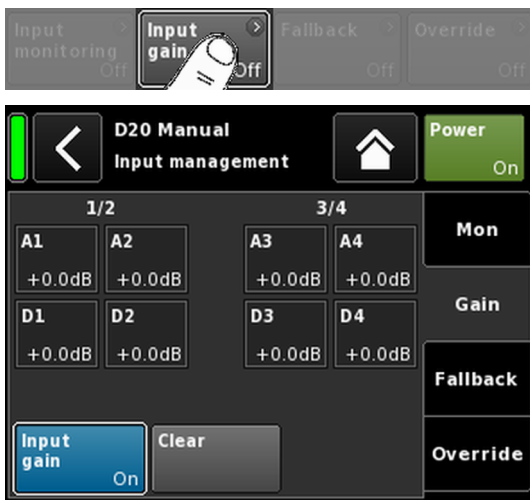
**11.2.2.2. Input gain**

Selecting «Input gain» from the «Input settings» menu opens the corresponding subscreen.

An additional preamplifier stage (gain pot) is provided for each input channel, either analog or digital.

This allows either analog or digital audio sources to be directly connected to the respective amplifier input channels and presets their upstream gain ranging from -57.5 dB to $+6$ dB in steps of 0.5 dB.

By factory default the input gain is set to 0 dB.

At the bottom of the screen two buttons are located providing the following functions:

Input gain

Master On/Off switch.

The on/off status is indicated by a change in color of the button from grey to blue or vice versa.

Clear

All gain settings are reset to factory default (0 dB) while the function remains activated.

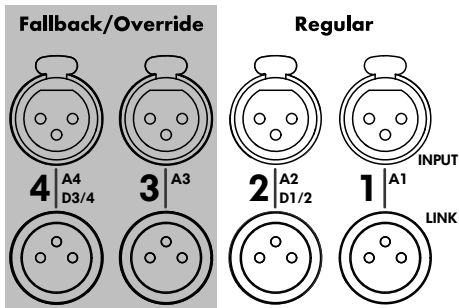

11.2.2.3. Fallback

The Fallback function enables the definition of primary (Regular) and secondary (Fallback) signal paths for analog and digital input signals with two different modes (Manual or Auto). This ensures that any secondary or emergency signal fed to the Fallback inputs is transmitted when required.

For this purpose, the input section is split in two logical groups:

- **Regular** signals only on input connector pair **1/2**.
- **Fallback** signals only on input connector pair **3/4**.

Note: The Fallback and Override functions can be used simultaneously. However, please note that in this case input 3 is no longer available as fallback input.

Selecting «Fallback» from the «Input settings» menu opens the corresponding subscreen.



Off

Disables the function. The On/OFF status is also displayed on the «Input settings» screen.

Manual

The desired signal path («Source») can be selected manually, either locally or via the Web Remote interface or via the d&b Remote network using R1.

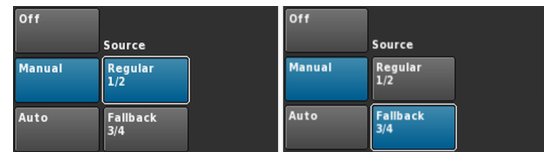

Auto

To enable the automatic switch, Input monitoring («Mon») must be activated and correspondingly parameterized. The desired signal path («Source») can be selected manually, either locally or via the Web Remote interface or via the d&b Remote network using R1.

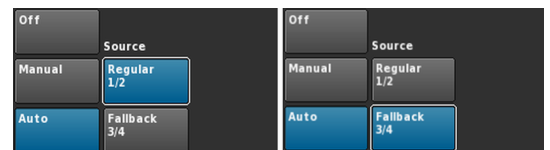

After the Fallback function has been triggered, it can be reset manually by reactivating (selecting) the «Regular 1/2» input source.



This can be done either locally or via the Web Remote interface or via the d&b Remote network using R1.

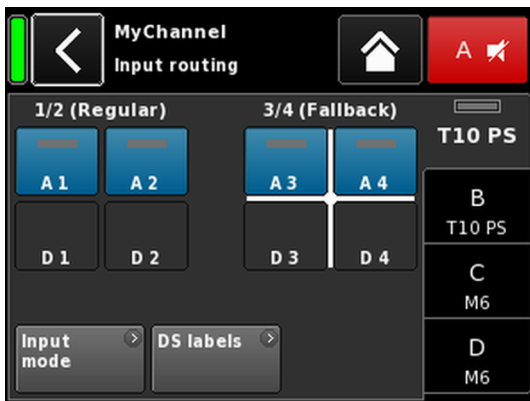

Fallback settings example
 A1/A2 Regular, A3/A4 Fallback.
 Fallback inputs are active.

When the Fallback function is activated, the Input routing screen is divided into two groups, «Regular» and «Fallback».

Regular inputs are always input pair 1/2, Fallback inputs are always input pair 3/4.

The white cross indicates which of the groups is currently active (as shown in the graphic opposite).

Note: Any input selected as Fallback input is disabled in the Input routing menu.

The Input routing settings are stored when the device switches to Fallback mode. When the Fallback mode is deactivated (either manually or automatically), the last Input routing settings defined are restored.

Fallback (FB) and detection modes

Input fallback automatically switches from the selected input source to another (Fallback) input source when either a digital (AES) sync signal (Lock) or a pilot signal (Pilot) or both of them are missing.

In conjunction with a Dante Audio Network, a fallback can also be triggered when a connected d&b DS-Series device detects that the Dante channel is not available on either the Primary and/or Secondary network (DS data).

The following Fallback (FB) and detection modes are supported:

FB Mode	Input source	Detection	FB Input source
A ⇒ A	A1/A2	Pilot	A3/A4
A ⇒ D	A1/A2	Pilot	D3/D4
D ⇒ A	D1/D2	Pilot/Lock/DS data	A3/A4
D ⇒ D	D1/D2	Pilot/Lock/DS data	D3/D4

Examples:

1. In Fallback mode A ⇒ A, an output channel routed to input A1/A2 will be fed by A3/A4.
2. In Fallback mode A ⇒ D, an output channel routed to input A1 will be fed by D3.
3. In Fallback mode D ⇒ A, an output channel routed to input D1/D2 will be fed by A3/A4.
4. In Fallback mode D ⇒ D, an output channel routed to input D1 will be fed by D3.

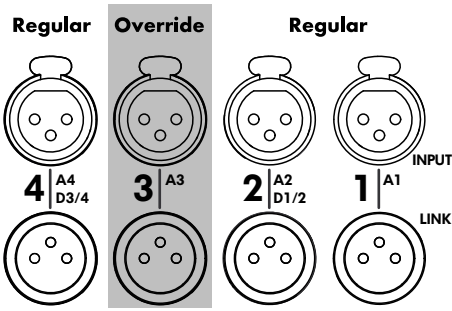

11.2.2.4. Override

The Override function is available for analog input A3 only.

The Override function allows analog input A3 to be set as a major signal path. When the function is activated, the input has the highest priority for general messages or emergency services.

When Override is activated, the analog input A3 is disabled on the Input routing screen and «Override» is displayed (flashing when active).



Selecting «Override» from the «Input settings» menu opens the corresponding subscreen.



Off

Disables the function. The On/Off status is also displayed on the «Input settings» screen.

Manual

The desired signal path («Source») can be selected manually either locally or via the Web Remote interface or via the d&b Remote network using R1.

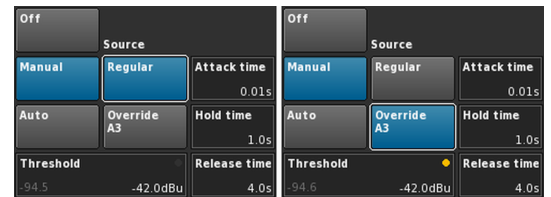

Auto

With this mode selected, the analog input A3 is permanently monitored. As soon as the incoming signal level exceeds the defined threshold, input A3 will be opened depending on the set Attack time. All other channels will be muted (Gate + Ducking).

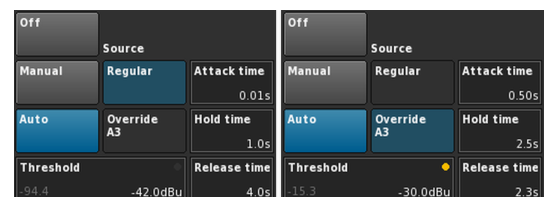

As soon as the signal level drops below the threshold, input A3 will be muted while all other channels will be unmuted depending on the set Hold and Release times (crossfade).

Threshold

Threshold level, adjustable from -42 dBu to +25 dBu in 1 dBu increments. At the bottom left, the actual level of the incoming signal is displayed in light grey. In addition, an LED indicator is provided at the top right. As long as the incoming signal level is below the set threshold, the LED illuminates yellow and changes to green as soon as the level exceeds the threshold.



- Attack** Attack time, adjustable from 0.01 sec. to 1 sec. in 0.01 sec. increments.
- Hold** Hold time, adjustable from 0 sec. to 10 sec. in 0.1 sec. increments.
- Release** Release time, adjustable from 0 sec. to 10 sec. in 0.1 sec. increments.

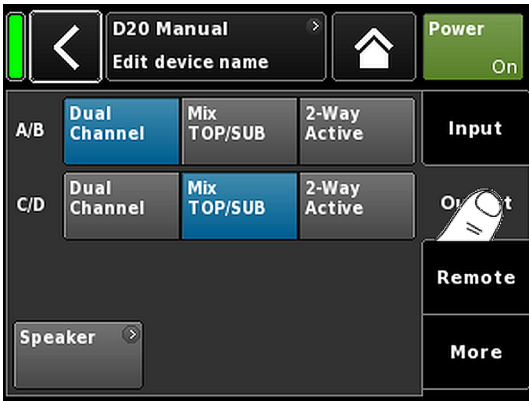

11.3. Output

Selecting the «Output» tab allows you to assign the appropriate Output mode to a pair of amplifier output channels (AMP A/B and/or AMP C/D).

The following Output modes can be assigned to a pair of amplifier output channels (AMP A/B and/or AMP C/D).

- Dual Channel
- Mix TOP/SUB
- 2-Way Active
- Mixed configurations

⇒ A change of the Output mode must be confirmed. This is done by selecting either the Back (⏪) or the Home (🏠) button.

⇒ The set Output mode will be activated and the corresponding channels will be muted.

Note: Changing the Output mode directly affects the available range of loudspeaker setups.

On the Home screen, the selected Output mode is displayed in the header area below the device name.

The channel strips below the Header section change depending on the chosen modes as shown below.

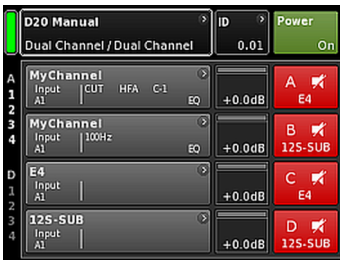

2 x Dual Channel



2 x Mix TOP/SUB



2 x 2-Way Active



Mixed configuration



On the bottom left of the Output screen, the «Speaker» navigation button provides direct access to the ⇒ Speaker setup screen.

11.3.1. Output mode

NOTICE!

- Ensure that the connected loudspeaker type corresponds to the actual output configuration of the D20.
- Observe the dedicated NL4 connectors to be used.

Dual Channel mode (A/B, C/D)

The Dual Channel mode is dedicated to d&b fullrange systems (passive systems) and actively driven d&b subwoofers. Both channels of each pair of amplifier channels can be configured for TOP or SUB cabinets independently.

In Dual Channel mode each pair of amplifier output channels (AMP A/B, AMP C/D) acts as a two channel amplifier (stereo amplifier). The amplifier channels are connected to their corresponding output connectors (AMP A to OUT A ...) while the audio input for each amplifier channel can be assigned via the input routing.

Each output connector is wired in parallel using the respective pins for TOP or SUB configurations.

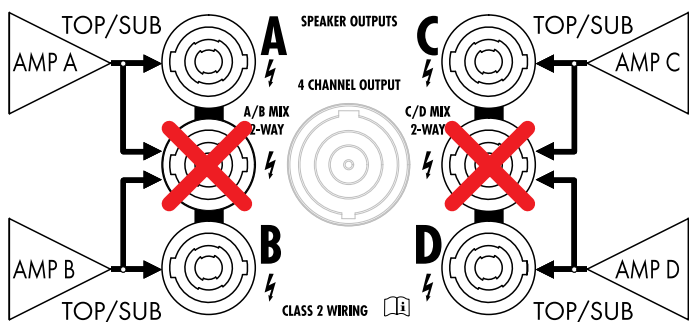
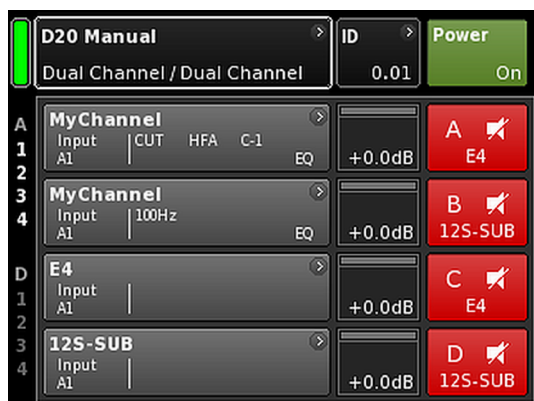

2 x Dual Channel mode

SPEAKER OUTPUTS A (B, C, D):

- 1+/2+ = Amp A (B, C, D) pos.
- 1-/2- = Amp A (B, C, D) neg.

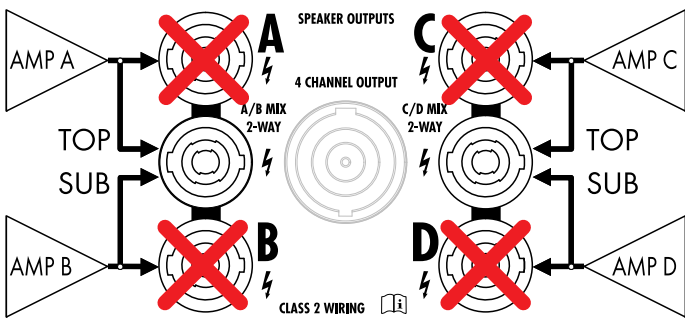
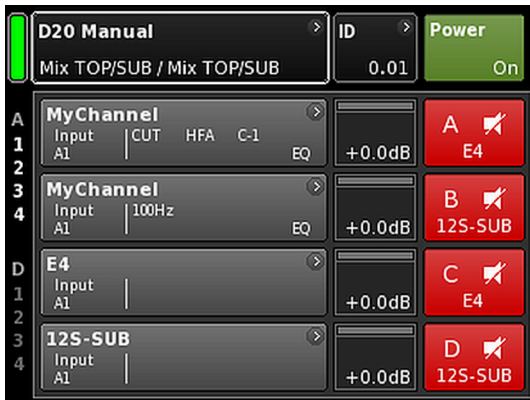

2 x Mix TOP/SUB mode

Mix TOP/SUB mode (A/B MIX, C/D MIX)

The Mix TOP/SUB mode allows d&b fullrange systems (passive systems) and actively driven d&b subwoofers to be linked together and connected to the amplifier using a single 4-wire cable.

TOP cabinets (setups) can be selected on channel A (C) and SUB cabinets (setups) on channel B (D).

In Mix TOP/SUB mode both amplifier channels of the corresponding pair (AMP A/B, AMP C/D) are connected to both output connectors (AMP A and AMP B to OUT A and OUT B ...) while the audio input for each amplifier channel can be assigned via the input routing.

Two output connectors (A/B, C/D) are wired in parallel using the respective pins for TOP and SUB configurations.

SPEAKER OUTPUTS A/B (C/D):

- 1+ = Amp A (C) pos. (TOP)
- 1- = Amp A (C) neg.(TOP)
- 2+ = Amp B (D) pos. (SUB)
- 2- = Amp B (D) neg. (SUB)

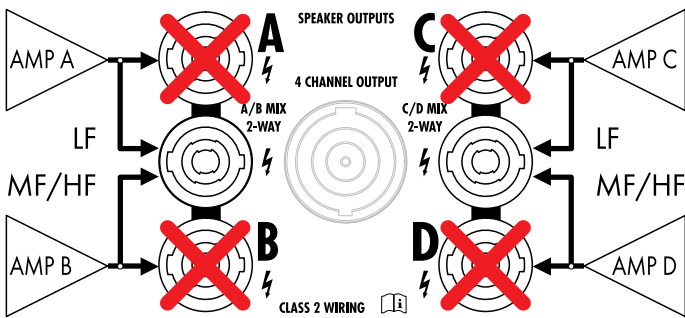

2 x 2-Way Active mode

2-Way Active mode (2-WAY)

The 2-Way Active mode is dedicated to d&b active systems.

In 2-Way Active mode both amplifier channels of the corresponding pair (AMP A/B, AMP C/D) are connected to both output connectors (AMP A and AMP B to OUT A and B ...). The audio input for each pair of amplifier channels can be assigned via the input routing.

All settings of channel A (C) and the corresponding input signal are internally linked to channel B (D).

SPEAKER OUTPUTS A/B (C/D):

- 1+ = Amp A (C) pos. (LF)
- 1- = Amp A (C) neg.(LF)
- 2+ = Amp B (D) pos. (MF/HF)
- 2- = Amp B (D) neg. (MF/HF)



Mixed configurations

As the output mode is assigned to a pair of amplifier channels (AMP A/B, AMP C/D) mixed configurations such as ...:

- AMP A/B ⇒ Dual Channel, AMP C/D ⇒ 2-Way Active
- AMP A/B ⇒ Dual Channel, AMP C/D ⇒ Mix TOP/SUB
- AMP A/B ⇒ Mix TOP/SUB, AMP C/D ⇒ 2-Way Active

... as well as all other combinations are also possible.

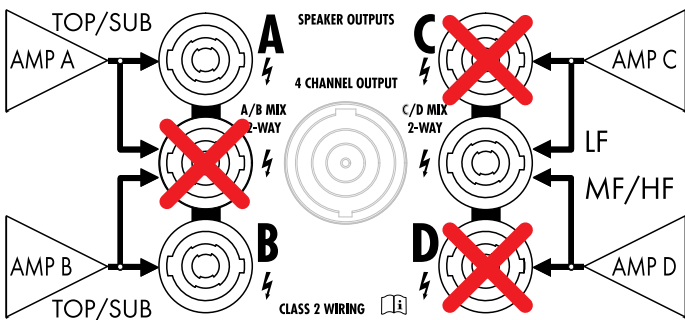

Mixed configuration example

AMP A/B ⇒ Dual Channel, AMP C/D ⇒ 2-Way Active

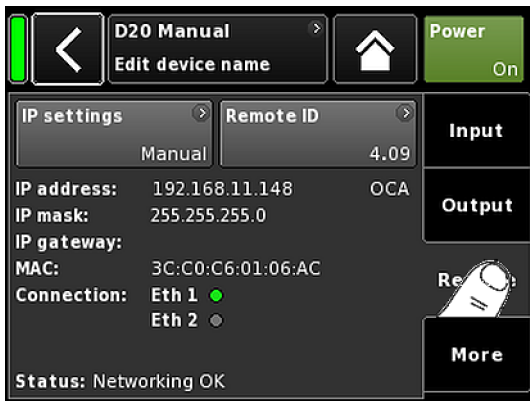

11.4. Remote

Selecting the «Remote» tab allows you to assign remote settings for both Ethernet and CAN remote control.



11.4.1. IP settings

Selecting the navigation field «IP settings» enters the corresponding subscreen. In addition, the IP mode is displayed at the bottom right of the navigation field.

IP address IP mask IP gateway

Selecting either field opens the numerical input mask and allows you to enter the relevant data.

Wrong entries can be corrected by tapping the Erase button (⌫) on the bottom right.

Tapping «OK» on the top right confirms the entry, closes the input mask and switches back to the Remote screen.

Tapping the Back button (⏪) on the top left cancels any entry and switches back to the Remote screen keeping the previous entry.

IP mode

Selecting this field enables the following settings:

Manual

Allows the manual assignment of IP settings.

DHCP+FB

When the device is connected to a network with a DHCP server present, a matching IP address is assigned automatically.

If no DHCP server is present on the network, the IP will fall back (FB) to the manual IP addressing. If a DHCP server becomes available later, an IP address will be automatically assigned later.

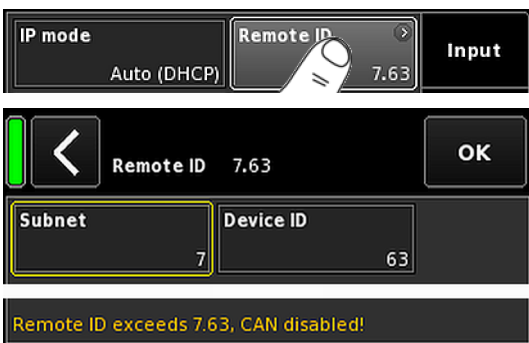
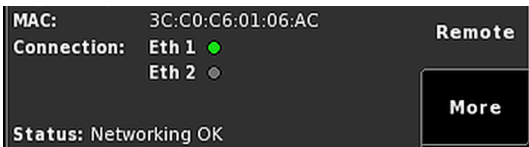

Set gateway to default

When this button is selected, the gateway address is derived from the IP address and IP mask settings.

Additional information fields

- MAC:** Displays the fixed MAC address of the device.
- Conn.:** Shows which of the etherCON connectors is connected (busy).
- Status:** Provides status information on the network.

11.4.2. Remote ID

Selecting the «Remote ID» button allows the setting of the unique Remote identifier of the respective device in the format [nn].[nn].

Subnet

The first two digits represent the subnet.

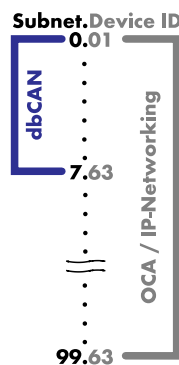

Within an **Ethernet network** up to 100 subnets can be defined (values 0 to 99).

Within a **CAN network** up to eight subnets can be defined (values 0 to 7).

Note: In case of a Subnet mismatch the following message is issued at the bottom of the screen:

Remote ID exceeds 7.63, CAN disabled!

Device ID

Using the two digit Device ID for each subnet, you can define a total of 63 devices (values 1 to 63).

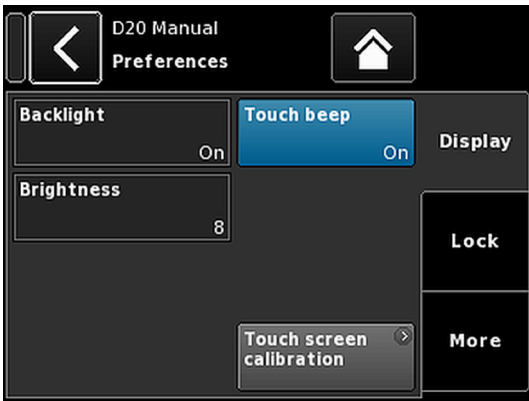
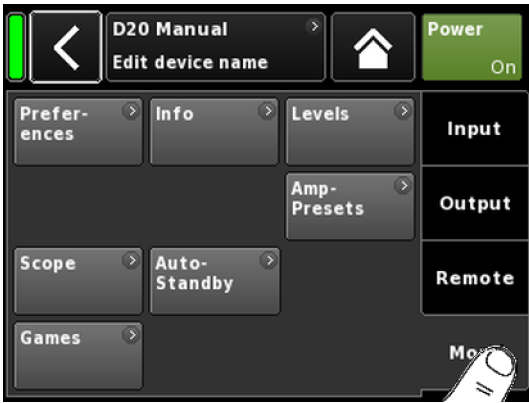

11.5. More

Selecting the «More» tab provides further subscreens such as:

- Preferences
- Info
- Levels
- ...

11.5.1. Preferences

Selecting «Preferences» opens the corresponding subscreen with the «Display» tab being active.

11.5.1.1. Display

The «Display» tab provides the following display options.

Backlight

Enables the following optional settings:

- Off** The display brightness is set to 1 (minimum brightness).
- On** The backlight is permanently on.
- Timeout 10s** The display is illuminated when the encoder is pressed or when the display is touched. The light switches off automatically 10 seconds after the last operation.

Note: This setting is recommended to increase the lifetime of the display.

Brightness

Enables adjustment of the display brightness in the range from 1 to 10. The default setting is 8.

Touch beep

Enables or disables the beep sound when using the touch screen.

Touch screen calibration

Due to mechanical impact or the aging process of the touch screen, its calibration references may change.

An indication is that when you tap a specific button and the adjacent button is activated instead or when a specific button does no longer work.

In such cases, the touch screen should be recalibrated.

To calibrate the touch screen, proceed as follows:



1. Select «Touch screen calibration».
 - ⇒ The Screen calibration menu will open guiding you through the calibration process.
2. Follow the relevant on-screen instructions.

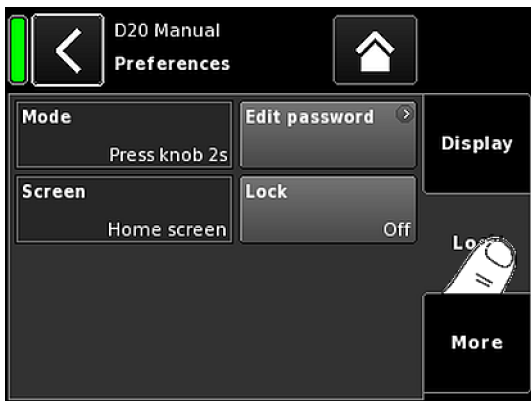

11.5.1.2. Lock

Selecting the «Lock» tab opens the corresponding subscreen which enables different protection settings.

Mode

Selecting «Mode» toggles between two options to protect the device against unintentional operation.

Press knob 2s Prevents accidental operation by locking the front panel controls.

Password Enables password protection to prevent operation by unauthorized persons.

Screen

Selecting «Screen» allows two different settings for the screen when the device is locked.

Home screen Switches to the Home screen.

Levels Switches to the Levels screen.

Edit password

Selecting the «Edit password» option opens an input mask which enables you to edit or assign a password (upper-case characters with a maximum length of 7 characters).

Wrong entries can be corrected by tapping the Erase button on the bottom right (⌫).

Tapping «OK» on the top right confirms the entry, closes the input mask and switches back to the Lock screen.

Tapping the Back button (⏪) on the top left exits the input mask and leaves the previous password unchanged.

Note: The factory default password is: DBAUDIO



Lock

Tapping the «Lock» button confirms any new settings and exits the subscreen. A corresponding message is displayed.

The device will be switched to the screen selected for Lock mode.

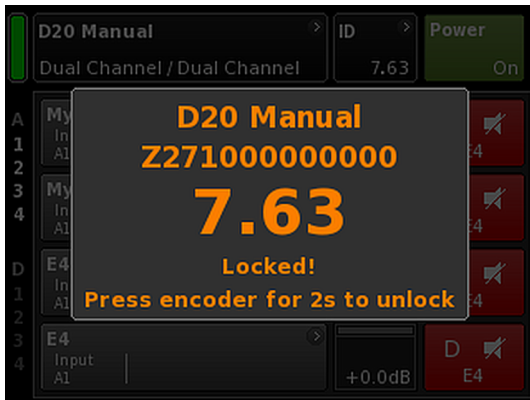

Unlocking the device

If you attempt to change the status of the device while it is in Lock mode, the following message will be issued: Press encoder for 2s to unlock. To unlock the device, proceed as follows:

- Press ...** Press and hold the encoder for a minimum of 2 seconds until the message disappears.
- Password**
1. Press and hold the encoder for a minimum of 2 seconds until the corresponding input mask is displayed.
 2. Enter the password as described above. An incorrectly entered password will revert the device to the screen displayed for Lock mode.

If the password is lost or forgotten, a locked device can be unlocked by performing a system reset.

Note: All device preferences will be set to factory defaults except for the network (CAN/Ethernet) and fixed device settings.

If you execute this procedure, no dialog will be prompted and the reset will start immediately.

1. Switch off the device.
2. Press and hold the encoder and repower the device.
⇒ Long confirmation beep.
3. Release the encoder and briefly press the encoder again within 2 sec.
⇒ Short confirmation beep.
The device will boot up and will switch to the Home screen. A corresponding message will be issued:

All device settings have been cleared

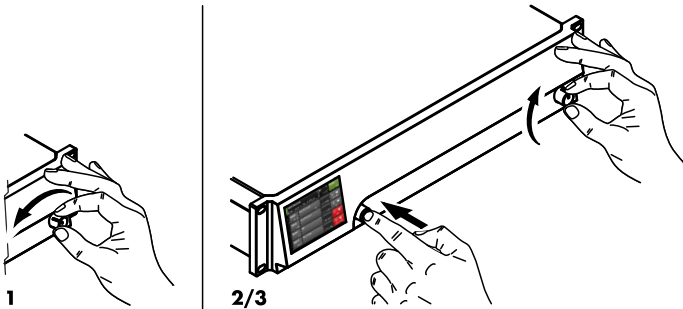

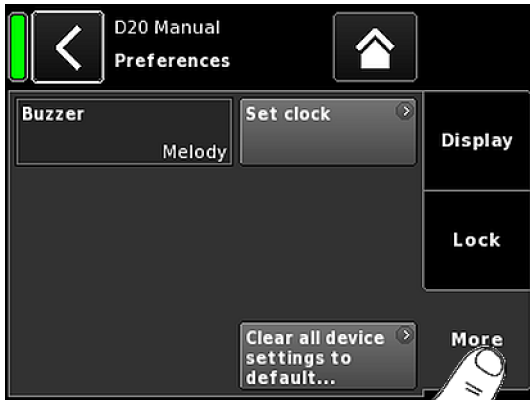

11.5.1.3. Preferences/More

Selecting the «More» tab opens the corresponding subscreen which provides the following options.

Buzzer

Enables the following settings:

- Off** The internal buzzer is switched off.
- On** The internal buzzer is switched on and serves as an acoustic signal in case of a device or channel error.
- Single** The internal buzzer generates an intermittent single tone.
- Melody** The internal buzzer generates a predefined sequence of tones.

Set clock

Enables setting the internal clock while the current UTC (Coordinated Universal Time) date and time are displayed at the bottom of the screen.

Within a Remote network, the device's clock is synchronized with the connected PC.

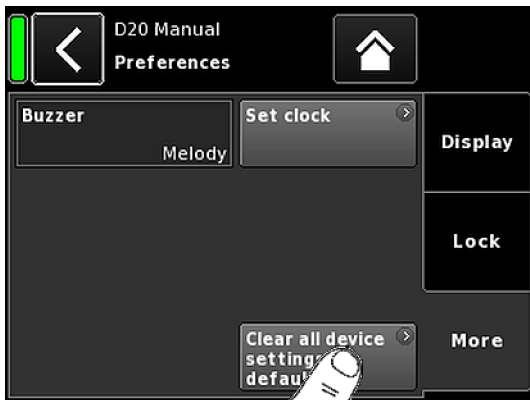
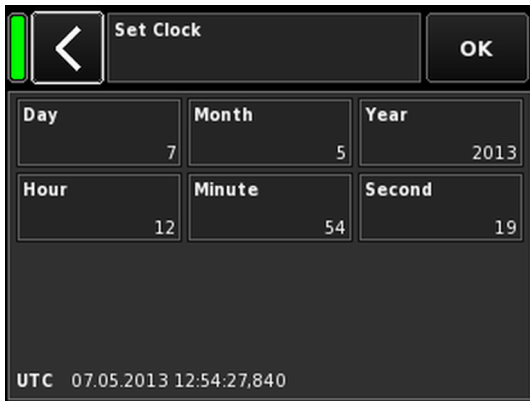

11.5.1.3.1. System reset

Selecting «Clear all device settings to default» resets all device settings to factory defaults except for the network (CAN/Ethernet) and fixed device settings.

To prevent accidental reset when you tap the «Clear...» button, a dialog will pop up prompting you to confirm the reset or cancel the sequence by tapping the Back button (⏪).



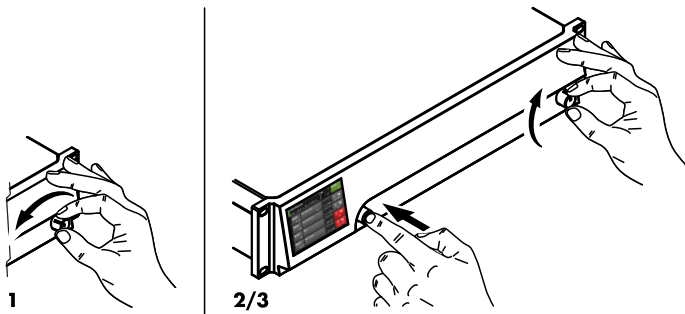

Alternative procedure

A system reset can also be triggered as follows:

Note: All device preferences will be set to factory defaults except for the network (CAN/Ethernet) and fixed device settings.

If you execute this procedure, no dialog will be prompted and the reset will start immediately.

1. Switch off the device.
2. Press and hold the encoder and repower the device.
⇒ Long confirmation beep.
3. Release the encoder and briefly press the encoder again within 2 sec.
⇒ Short confirmation beep.
The device will boot up and will switch to the Home screen. A corresponding message will be issued:

All device settings have been cleared

11.5.2. Info

Selecting «Info» provides basic information about the device.

The information provided is mainly intended for service purposes.

Most of the information is static information, for example:

- Various firmware versions (Firmware Core/DSP/PS/AMP)
- Serial number
- Owner

In addition, there is dynamic information about the actual temperatures of... :

- Power supply (Temp. PS)
- The entire power amplifier (Temp. AMP)
- Central Processing Unit (Temp. CPU)

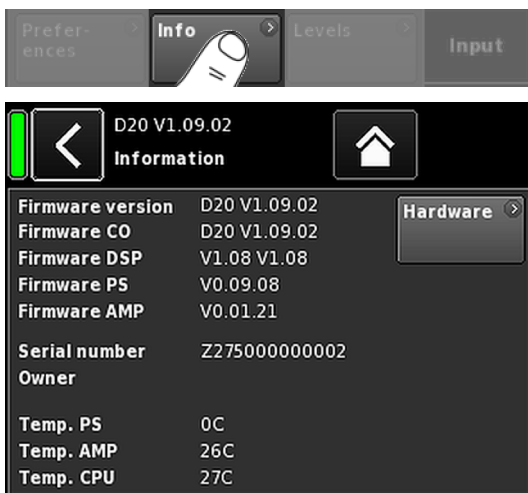

Selecting the «Hardware» button provides further hardware specific information.

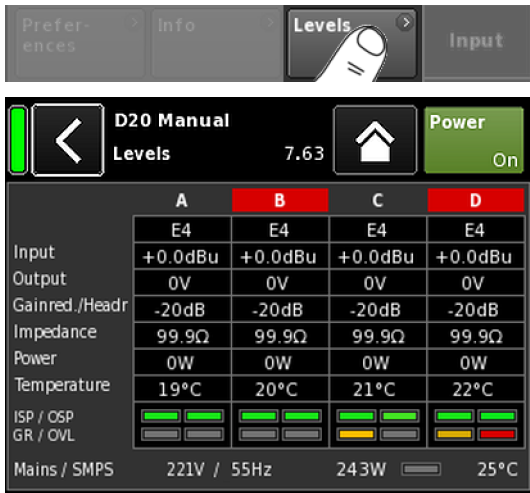

11.5.3. Levels

Selecting «Levels» opens the corresponding subscreen.

The data area of the levels screen provides the following information (starting at the top left):

- 1st line** Mute status of each channel.
- 2nd line** Loudspeaker setups selected for the individual channels.
- Input** Current input signal levels of the individual channels.
- Output** Current output voltages of the individual amplifier channels.
- Gainred/Headr** Relationship between headroom (Headr) and gain reduction (Gainred) with peak hold for 1 sec.
Display ranges:
Gainred 0 dB ⇒ +32 dB.
Headr -32 dB ⇒ 0 dB.
- Impedance** Current load impedance values for the individual amplifier channels.
- Power** Power currently delivered by the individual amplifier channels.
- Temperature** Current temperatures of the individual amplifier channels.
- ISP/OSP** Indicates whether the input signal (ISP) as well as the controller output signal (OSP) of the individual channel are present.
- GR/OVL** Indicates whether gain reduction (GR) of the respective channel is active or the respective channel is overloaded (OVL).
- Mains/SMPS** Displays the current mains voltage and frequency, the current mains power consumption in combination with a power limiter LED and the current temperature of the switched mode power supply (SMPS).

11.5.4. AmpPresets

d&b amplifiers provide AmpPresets which contain all important user settings of the entire device, such as input, output and channel configurations, EQ and delay settings.

Using AmpPresets, a sound system can be operated in different configurations (e.g. "Conference", "Music" or "Emergency Call") without the need of transferring all detailed settings of the devices used.

There are three types of AmpPresets memories (slots):

- User:** Nine (9) AmpPresets which can be accessed locally or via the d&b Remote network. These presets are used to set the complete device to a previously defined configuration for a particular application. They can be named individually.
- Alarm:** Three AmpPresets which can only be accessed via the d&b Remote network. Intended for use in alarm systems to protect the system settings against local modifications.
- Backup:** Three AmpPresets which can only be accessed via the d&b Remote network. Intended for temporary use to back up the current system settings when another AmpPreset is loaded.

Selecting «AmpPresets» opens the corresponding subscreen which provides the functions «Select», «Name», «Recall», «Store» and «Clear».

At the bottom of the screen, the last AmpPreset number loaded is indicated. If any setting has been modified since loading, «(modified)» will be added to the corresponding entry.

Select: Provides access to the nine (9) user preset memories (slots) for loading, saving or clearing data.

Name: Enables the assignment or editing of a preset name (maximum of 15 characters). The input mask which appears allows either lower-case or upper-case characters by toggling the corresponding button («abc») on the bottom left.

- Wrong entries can be corrected by selecting the Erase button (⌫) on the bottom right.
- Selecting «OK» on the top right confirms the entry, closes the input mask and switches back to the AmpPresets screen.
- Selecting the Back button (⏪) on the top left cancels any entry and switches back to the AmpPresets screen keeping the previous entry.





Recall: Recalls the settings of a stored preset.

Store: Stores the current amplifier settings to the selected preset memory.

Clear: The selected preset memory is cleared and «(empty)» is displayed on the «Name» button.



Note: Choosing one of these functions, a corresponding confirmation dialog will be issued to allow either confirmation of the selection or to cancel the action by selecting the Back button (⏪).

11.5.5. Scope

The «Scope» function allows basic signal monitoring of the amplifier's output voltage (full color) and output current (light color).

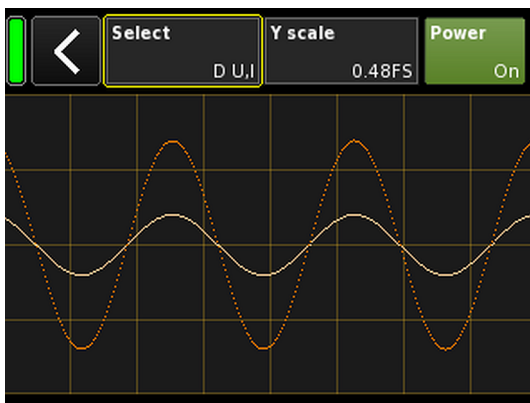

Select

A U, I Output voltage and current of channel A.

B U, I Output voltage and current of channel B.

C U, I Output voltage and current of channel C.

D U, I Output voltage and current of channel D.

All U Output voltage of all channels.

All I Output current of all channels.

All U, I Output voltage and current of all channels.

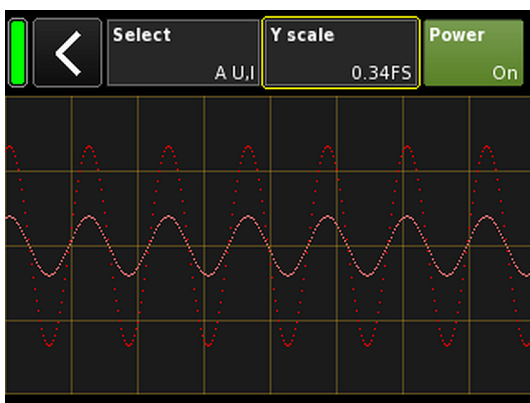

Y scale

Scale of the measuring values in FS (Full Scale). 1.0 FS represents the maximum output voltage or output current.

Application examples

The scope function is a useful tool for ...:

- determining the signal quality.
- determining a phase shift between the channels.
- getting a rough impression of the crest factor.
- checking the output channels (e.g. no output current displayed ⇒ the connector cable may be interrupted or no loudspeaker is connected).
- checking the power amplifier (e.g. no output voltage displayed).

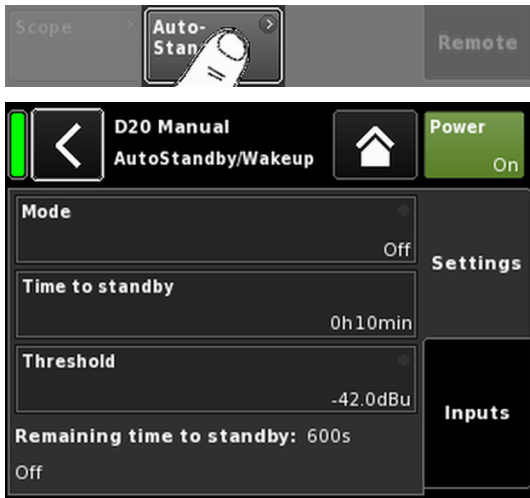

11.5.6. AutoStandby

Selecting «AutoStandby» opens the corresponding subscreen with the «Settings» tab being active.

The AutoStandby function automatically switches the amplifiers to Standby mode after a predefined time when the incoming signal level at the individually specified inputs drops below a defined threshold. The function is independent of the mute status of the respective channels.

The AutoWakeup function automatically repowers the amplifier within 1.5 seconds when an input signal is present and exceeds a defined threshold.

Note: The AutoWakeup function only applies to the digital inputs.

Settings tab

Mode

Off:

Disables the function.

AutoStandby:

Enables the function. When the function is activated, the device will switch to Standby mode after the predefined time.

AutoStandby&AutoWakeup:

Enables the function. When the function is activated, the device will switch to standby mode after the predefined time and will be repowered within 1.5 seconds when an input signal is present and exceeds the defined threshold.

Time to standby

Time (count down), adjustable from 1 min. to 24 h. in 1 min. increments.

Threshold

Threshold for the AutoWakeup function, adjustable from -140 dBu to +25 dBu in 1 dBu increments.

Remaining time to standby

Non-editable information field. In addition to the count down of the remaining time, various status details are displayed depending on the given settings.

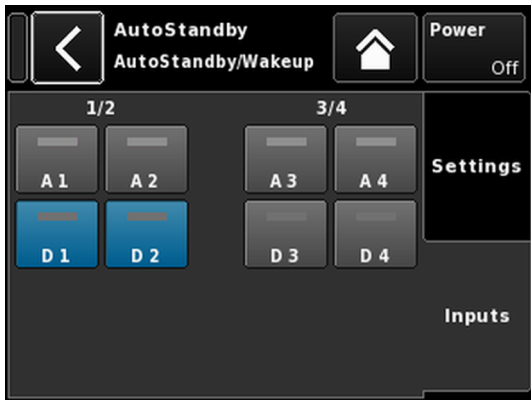

Inputs tab

When the AutoWakeup function is enabled, the corresponding inputs that will be monitored for incoming signals can be specified.

12. Channel setup

Channel setup access chart

Hierarchy level

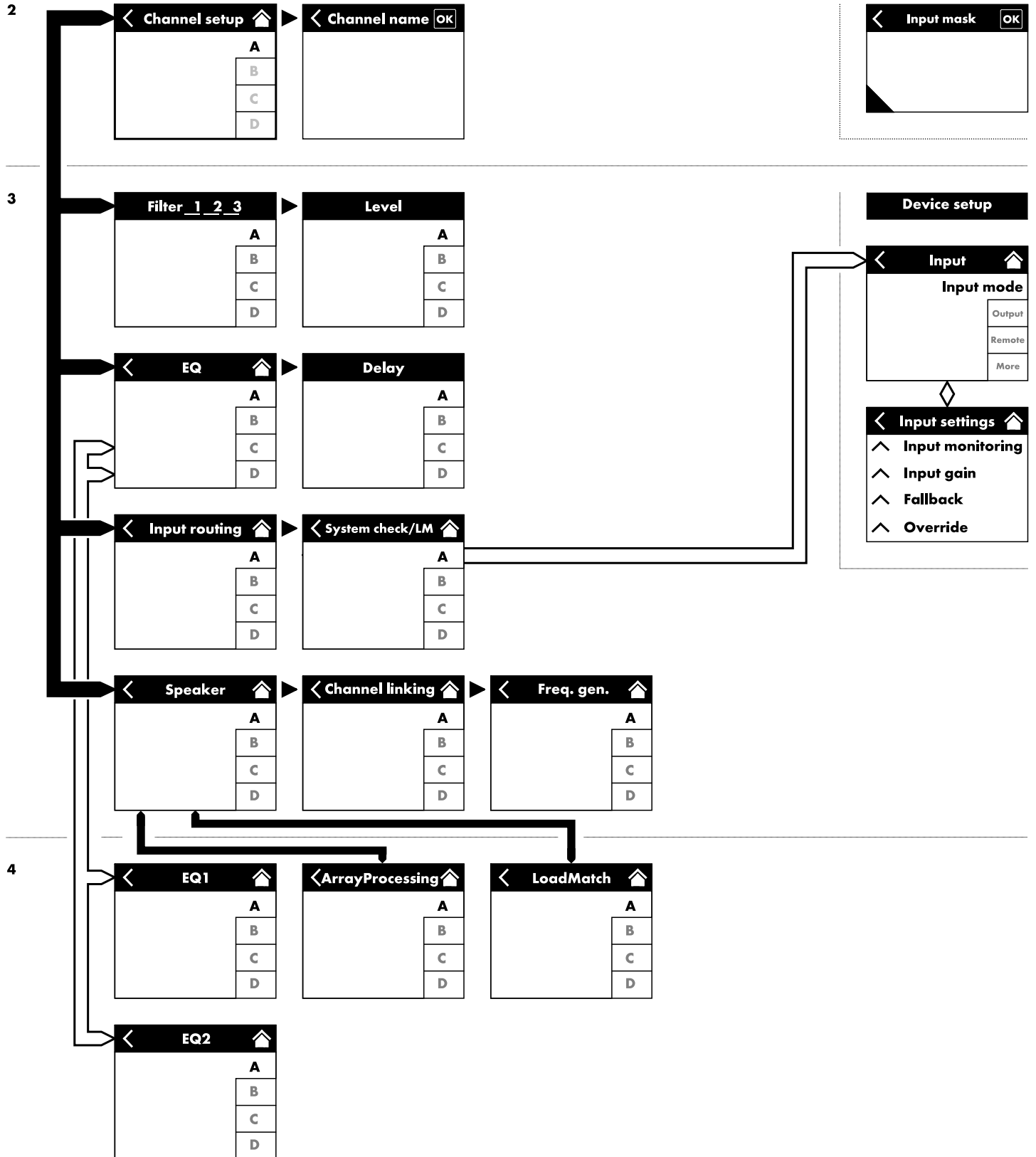



Selecting a particular channel from the Home screen opens the corresponding Channel setup screen with the respective Channel tab being active.

The Channel setup screen follows the same layout structure as described above and is split into the Header and the Data sections.

Using the tabbed structure of the Channel setup screen provides direct access to the desired function element of each channel.

In addition, the «Channel mute» button of the selected channel as well as the "OSP", "GR" and "OVL" indicators for each channel are available. This allows you to maintain the integrity of the gain structure within the unit while setting up the user definable EQ as well as keeping an eye on the Input routing.



12.1. Channel name

Selecting the centered Information field button («Edit channel name») in the header of the Channel setup screen enables you to enter or edit the Channel name (maximum length 15 characters).

The input mask which appears allows either lower-case or upper-case characters by toggling the corresponding button («abc») on the bottom left.

Wrong entries can be corrected by tapping the Erase button (X) on the bottom right.

Tapping «OK» on the top right confirms the entry, closes the input mask and switches back to the channel setup screen.

Tapping the Back button (◀) on the top left cancels any entry and switches back to the Channel setup screen keeping the previous entry.



12.2. Configuration switches - Filter_1, _2, _3

The type of filters available depends on the selected loudspeaker setup.

Depending on the type of filters, these are available as function buttons or input fields.

The name of the filter is displayed on the top left of the button or field while the On/Off status or the value is displayed on the bottom right. In addition, the On/Off status is also indicated by colors.

Filter_1	Filter_2	Filter_3
Configuration of crossover frequencies for TOP/SUB, e.g. CUT, 100 Hz, Infra ... Note: CUT in LINEAR setup: - Butterworth 2nd order (12 dB/oct.) - Corner frequency: 110 Hz - Amplifier gain @ 0 dB: 31 dB.	Compensation of listening distance, e.g. HFA, HFC. HFC: Off, +1 (HFC1), +2 (HFC2). CSA: Cardioid Subwoofer Array.	CPL ⇒ Array-EQ (compensation of coupling effects) CPL range: -9 dB ... 0 dB (Off): Cut (Lo shelf) 0 dB (Off) ... +5 dB: Boost (65 Hz, Bell)



On the Home screen, the On/Off status or the set values of the Configuration switches are indicated by the entry on the Channel view button of the corresponding channel strip, as shown in the graphic opposite.

Note: A detailed description of the filters available for each loudspeaker is given in the relevant loudspeaker manuals.

A detailed description of the CSA function (Cardioid Subwoofer Array) is given in the technical information TI 330 which can be downloaded from the d&b website at www.dbaudio.com.



12.3. Level

Input sensitivity of the respective power amplifier channel or set of channels (depending on the output mode), adjustable within a range of -57.5 dB to +6 dB in steps of 0.5 dB.

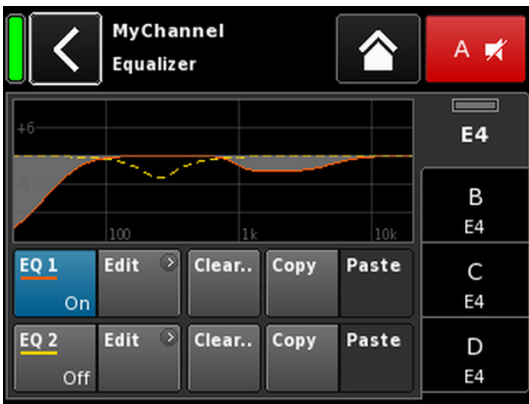
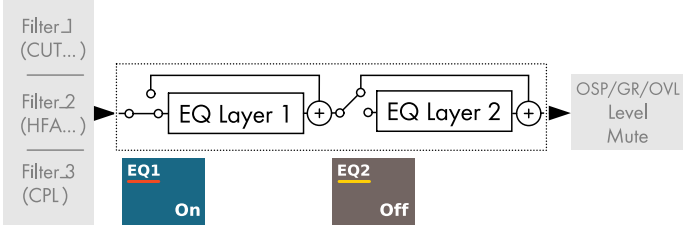

12.4. EQ - Equalizer

Selecting «EQ» opens the equalizer subscreen of the respective channel.

The graphic opposite shows the location of the equalizer (User EQ) within the signal chain.

The equalizer provides two independent and user definable 16-band equalizers (2 x 16 minimum phase biquad IIR filters, full parametric) and is split into two layers:

- ⇒ EQ overview,
- ⇒ EQ layer/curve.

EQ overview

The upper part of the overview provides the overall frequency response of all filters while «EQ 1» is displayed in red and «EQ 2» in yellow.

Active filters are displayed by continuous lines and the curves are filled with grey color while inactive filters are displayed by dashed lines.

The bottom part of the overview provides the following functions:

EQ [n] On/Off

Master On/Off switch for the respective EQ.

On the Home screen, the On/Off status of the equalizer is indicated by the entry «EQ» on the «Channel view» button of the corresponding channel strip, as shown in the graphic opposite.

Edit

Opens the corresponding subscreen (EQ layer/curve) for editing.

Clear...

Resets all filter settings of the corresponding EQ. To prevent accidental reset when you tap the «Clear...» button, a dialog will pop up prompting you to confirm the reset or cancel the sequence by tapping the Back button (⏪).



Copy/Paste

Allows the entire EQ settings of one channel to be copied/pasted to any other channel.

To do so, proceed as follows:



Step 1



Step 2



Step 3



Step 4

1. Select the channel EQ you want to copy.
2. Select «Copy».
 - ⇒ The «Paste» button becomes accessible.
3. Select the channel to which you want to paste the EQ settings.
4. Select «Paste».

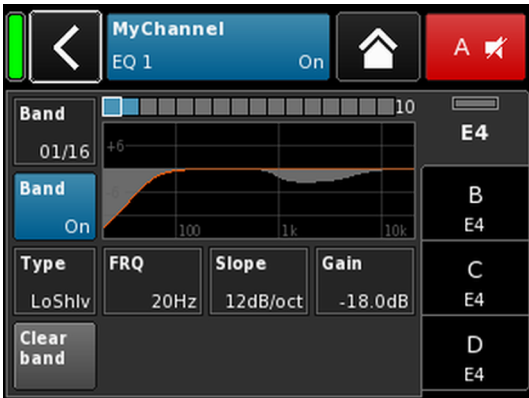

EQ layer/curve

Apart from the overall frequency response, the following functions and status indicators are provided:

Header section

EQ [n] - On/Off

On/Off status of the corresponding EQ.

This field also acts as On/Off switch for the respective EQ.

Data section

Line by line from left to right:

Band selector

Allows the selection of a filter band from the Filter band bar using the encoder.



Filter band bar



Displays all filter bands that are in use while the number of remaining filter bands is indicated next to the bar on the right.

Band On/Off

Switches the selected filter band on or off.

Type

Depending on the filter type used, 1 to 4 bands may be required for each filter.

The following table lists the available types, their corresponding parameters and the number of filter bands required for the selected type.

Type	Param. 1	Param. 2	Param. 3	Param. 4	Param. 5	No. of filters
PEQ (Parametric EQ)	FRQ	Q (and corresponding bandwidth - BW)	Gain			1
Notch	FRQ	Q (and corresponding bandwidth - BW)				1
HiShlv	FRQ	Slope	Gain			2
LoShlv	FRQ	Slope	Gain			2
Asym (Asymmetric filter)	FRQ 1	Slope 1	Gain	FRQ 2	Slope 2	4

Parameter ranges and resolutions:

Type The available filter types.

FRQ Filter frequency (center/corner frequency), adjustable from 20 Hz to 20 kHz.

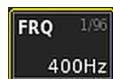

On the top right of the «Frequency/FRQ» input field, the increment is displayed as an octave value. When you tap the field for the first time, the frequency increment is set to 1/6 octave. When you tap the field again, you can toggle between 1/6 and 1/96 octave increments.

To confirm the set frequency, press the encoder.

**Q
BW** Q of the filter, adjustable from 0.5 ... 25 in 10 % steps.
In addition, the resulting bandwidth (BW) is displayed as a value (2.0 ... 0.04 octaves) in a non-editable Information field below the Q Input field.

Slope Slope can be set to 6, 12, 18 or 24 dB/octave.

Gain Gain, adjustable from -18 dB to +12 dB in 0.2 dB steps.

Clear band Resets all settings of the selected filter band right away.

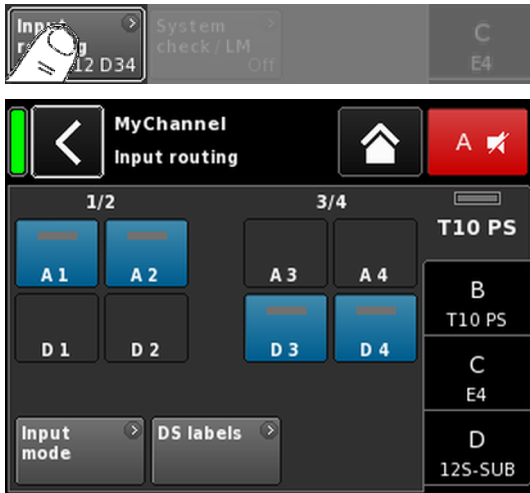

12.5. DLY - Delay

An independent signal delay is available for each channel to allow delay settings of up to 10000 ms/10 sec (3440 m/11286 ft).

DLY On/Off

Switches the delay on or off without affecting the entered delay values.

Set to "On" the set value will be applied right away.

Value

The delay time is adjustable from 0.3 to 10000 ms in steps of 0.1 ms or a corresponding value depending on the units selected.

Unit

Enables selection of the delay units, either milliseconds [ms], meters [m], feet [ft] or seconds [s].

A change in the units will be applied to all channels.

On the Home screen, the "On" status of the delay is indicated by the set value and unit on the Channel view button of the corresponding channel strip, as shown in the graphic opposite.

12.6. Input routing

Selecting «Input routing» opens the corresponding subscreen.

The input sources can be selected individually per amplifier channel or pair of amplifier channels (depending on the output mode setting).

Examples

Input mode	Routing
Analog/Analog	e.g. A1 + A3 (not: A1 + D3).
Digital/Digital	e.g. D1 + D3 (not: D1 + A3).
Analog/Digital	e.g. A1 + A2 (not: A1 + A3); D3 + D4 (not: D1 + D3).

Note: Provided the Input gain function is not activated, with two sources or more selected an attenuation of 6 dB will be applied.

The input routing is stored for every input mode setting. When the input mode setting is changed from analog to digital mode and back again, the input routing of the analog mode is recovered.

The Input routing screen also provides direct access to the ⇒ «Input mode» screen.

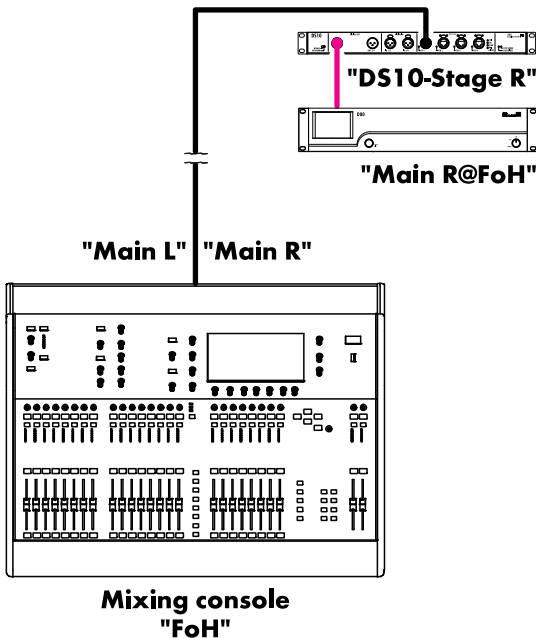
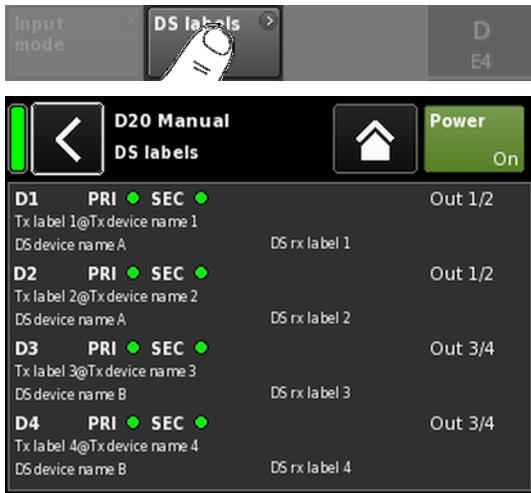

DS labels

Selecting the «DS labels» button opens the «DS labels» subscreen.

In connection with d&b DS devices, meta data such as Dante channel labels and cabling information are sent via the AES3 outputs alongside the digital audio samples using the AES3 User bits.

These meta data can be read out by the amplifier and displayed on this screen. The screen is split into three columns and the following information is provided for each of the digital inputs D1 - D4:

D[n]	PRI	SEC	Out [n]/[n+1]
Tx label@Tx Device			
DS device name		DS rx label	

D [n]

The corresponding input.

PRI/SEC

Indicates whether the Primary and/or Secondary Dante Audio Network is running (green - ●) or interrupted (gray - ●).

**Tx label@
Tx Device**

The Dante channel that is received at this amplifier input.

**DS device
name**

The name of the DS device connected to this amplifier input via AES3.

DS rx label

The configured Dante receive channel label for the DS output which is connected to this amplifier input.

Out [n]/[n+1]

The physical DS output connected to this amplifier input.

Example

A simple example is shown in the graphic opposite. The stream labels are stated in inverted commas. The corresponding labels and their locations on the screen are listed in the table below.

D1	PRI	SEC	Out 1/2
Main R@FoH			
DS10 Stage R		Front - Output 1	

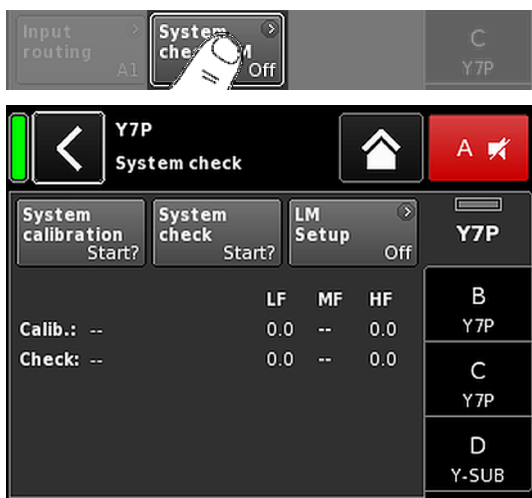

12.7. System check/LM

12.7.1. System check

System check is a powerful and convenient tool to check the condition of a complete d&b sound reinforcement system driven by d&b amplifiers. It is preferably used in conjunction with the d&b Remote network and the R1 software.

However, for smaller systems or single cabinets, System check can also be accessed and executed locally.

System check utilizes the amplifier's capability to measure the impedance (Z) connected to its outputs using a sine wave signal created by the DSP section of its controller.

Selecting «System check» opens the corresponding subscreen.

System check menu

The System check menu provides two buttons to start either a «System calibration» or a «System check» run.

In addition, a table is provided indicating the progress («Status») and the results (Z values) for both the calibration («Calib.:») and the check («Check:») runs.

The column header of the table for the Z values changes according to the connected loudspeaker cabinet, provided the respective loudspeaker setup is loaded.

Status Brief indication of the current status of the calibration or check process. In case of an error the status is indicated in red.

LF The calibration and check results for the LF section.

LF(R) The calibration and check results for the rear LF driver of an actively driven cardioid subwoofer, such as the J-SUB or J-INFRA.

MF The calibration and check results for the MF section of applicable cabinets.

HF The calibration and check results for the HF section.

System check procedure

The typical procedure using System check is as follows:

1. When the system is fully set up, check and verify all connections.
2. Mute all amplifier channels.
 - ⇒ The correct wiring of the system can now be tested by listening to each channel separately using an appropriate audio program and the MUTE switches - preferably controlled by R1.
3. As a next step, execute a **System calibration**.
 - ⇒ The calibration process identifies the actual load impedances for each channel. The result will be stored as a reference and used to calculate the upper and lower limits for the tolerance band.

To verify the correct connection of cabinets and amplifiers, the calibration result can be compared with the typical impedance values for d&b loudspeakers as listed in the ⇒ Appendix: "Typical impedance (Z) values" on page 92.

4. Run **System check**

- ⇒ Executing a System check after the event will repeat the measurement and display all values that are outside of the tolerance band, indicating a possible damage to the system components.

When a sound system is repeatedly used in the same configuration for which a calibration file exists, the System check procedure can also be used before the show to verify the system's correct setup.

A System check will only provide valid impedance values, if the amplifier has been calibrated before the check with the load connected or if a valid calibration file has been loaded using R1.

12.7.2. Load monitoring (LM)

Features

The d&b Load monitoring function is related to the System check function and serves to identify a possible loudspeaker malfunction.

Function

The calibration process, performed from the System check menu with the completely set up system, determines the impedance for each channel and calculates the related upper and lower impedance limits.

While the system is operating, d&b Load monitoring continuously monitors the load impedance separately for both frequencies. It detects any changes in loudspeaker impedance and reports an error if the limits are exceeded. For this purpose, Load monitoring uses inaudible pilot signals which are faded in for approximately 2 seconds in user defined intervals.

NOTICE!

The resolution of Load monitoring regarding failures of single components depends on the type and the number of loudspeakers connected to each channel.

The maximum number of cabinets which can be operated in parallel by one amplifier channel in order to be able to detect a failure of a loudspeaker component is listed in the ⇒ Appendix: "Max. number of cabinets operated in parallel" on page 94.

Load monitoring does not work if:

- the amplifier is switched off or switched to standby mode.
 - the respective channel is muted.
 - the pilot signal level is too low.
-

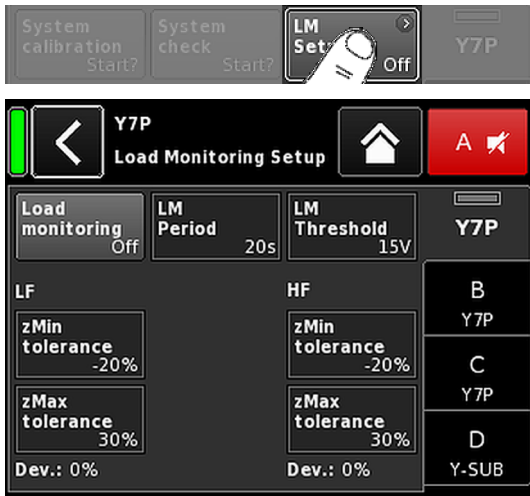

Load monitoring setup

On the «System check» screen, selecting «LM setup» opens the corresponding subscreen.

The «Load monitoring setup» menu provides all relevant parameters for adjustment to the on-site requirements.

Load monitoring On/Off Activates Load monitoring. The On/Off status is also indicated on the System check and Channel setup screens.

LM Period The maximum time in detents of 20 sec. it takes the system to detect a loudspeaker malfunction. The intervals of the pilot signal are derived from this parameter.

LM Threshold Large signal threshold. When the output signal exceeds this voltage level during the measurement, the tolerance limits for this particular measurement are increased in order to compensate for the reduced accuracy.

zMin tolerance Lower limit of the impedance window, which is set to -20 % by default.

zMax tolerance Upper limit of the impedance window, which is set to +30 % by default.

Dev.: Relative deviation in percent in relation to the reference values determined during calibration.

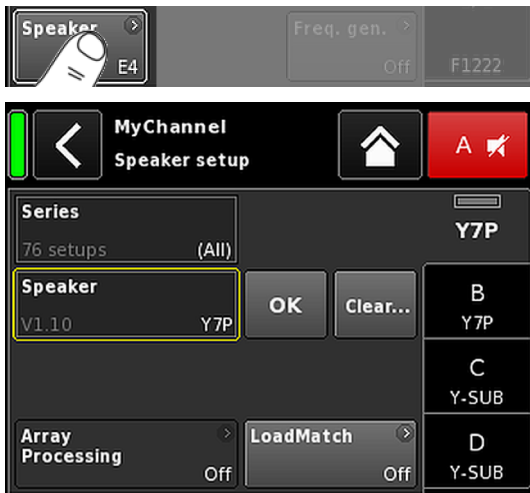

12.8. Speaker

Selecting «Speaker» opens the Speaker setup subscreen which enables the selection of loudspeaker setups for the applicable d&b loudspeakers (depending on the selected output mode).

The setups available are arranged in two blocks, «Series» and «Speaker».

- Back** (⏪) The Back button provides two options:
1. The selection has not been confirmed by tapping «OK» ⇒ Cancel: Exits the subscreen and the previous configuration remains active.
 2. The selection has been confirmed by tapping «OK»: Exits the subscreen.

Series The bottom left of the «Series» Input field displays the number of setups available while the bottom right displays the actual name of the Series.

The list is in alphabetical order, the starting point, however, is the Series currently loaded.

Selecting «(All)» provides direct access to all setups available and the LINEAR setup.

Speaker

The bottom left of the «Speaker» input field displays the version of the selected loudspeaker setup while the bottom right displays the actual setup name.

The loudspeaker list is either in numerical or alphabetical order depending on the selected series.

When «(All)» is selected in the «Series» field, the list starts with the numeric setup names followed by the remaining setup names in alphabetical order. The starting point, however, is the setup currently loaded.

OK

Selecting «OK» adjacent to the «Speaker» selection field confirms the configuration and the selected setup will be activated.

Clear...

To prevent accidental reset when you tap the «Clear...» button, a dialog will pop up prompting you to confirm the reset or cancel the sequence by tapping the Back button (⏪).



Selecting the «Clear...» button clears/resets the following loudspeaker related settings of the respective channel.

- Configuration switches (Filter_1, Filter_2, Filter_3) are reset.
- Level is set to 0 dB.
- Delay settings are reset (the selected unit will be kept).
- All EQ settings are disabled.

Array Processing

For applicable loudspeakers, the «ArrayProcessing» button becomes functional. It indicates the On/Off status of the function and provides direct access to the ArrayProcessing subscreen, which is described in ⇒ Chapter 12.8.1. "ArrayProcessing (AP)" on page 73.

Note: ArrayProcessing does not apply to all loudspeakers. When the function is not applicable, this button is not functional.

LoadMatch

For applicable loudspeakers, the «LoadMatch» button becomes functional. It indicates the On/Off status of the function and provides direct access to the LoadMatch subscreen which is described in ⇒ Chapter 12.8.2. "LoadMatch" on page 74.

Note: LoadMatch does not apply to all loudspeakers. When the function is not applicable, this button is not functional.



12.8.1. ArrayProcessing (AP)

Usually ArrayProcessing (AP) data are generated within the ArrayCalc software and transferred to the amplifiers via the d&b Remote network (OCA) using R1 V2.

However, once the ArrayProcessing data have been transferred to an amplifier remotely, each data slot may also be accessed locally.

AP slot

Selection field for each memory slot.

Note: The first slot (1) is reserved as a bypass slot.

Below the selection field, the slot name and version are displayed together with the comment for the slot that was previously entered in ArrayCalc.

In addition, the selected slot is indicated on the respective channel strip on the «Home» screen.

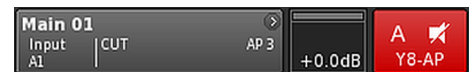

Clear all slots

Resets all slot data.



HF Trim (HFT)

As part of the ArrayProcessing feature, the HF Trim (High Frequency Trim) option allows you to trim the HF of a processed array due to changing air absorption conditions in the far field areas during a show.

The «HF Trim» option only becomes accessible when the «AP» setup of the relevant cabinets is loaded. HF Trim can be activated from the respective Channel screen and can be set locally or via the d&b Remote network using R1 V2. However, HF Trim will usually be applied for grouped cabinets using R1.

Off

No additional target distance.

+1/+2 **10% (+1) or 20% (+2)** additional target distance for each source.

The compensation is limited to an absolute additional distance of 30 m (100 ft).

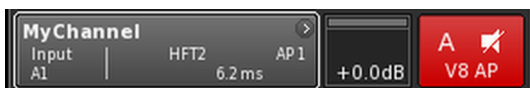

On the Home screen, the On/Off status and the setting of the HF Trim option is indicated by the entry «HFT[n]» on the «Channel view» button of the corresponding channel strip, as shown in the graphic opposite.

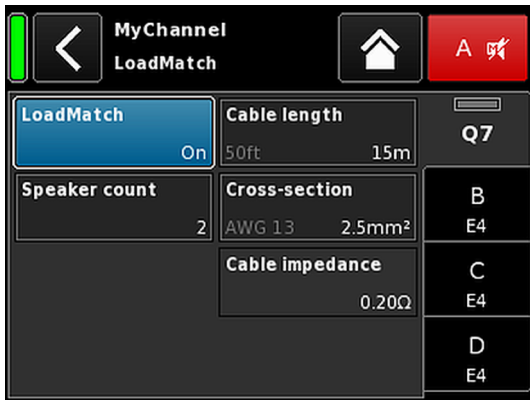

12.8.2. LoadMatch

Selecting «LoadMatch» on the Speaker setup screen opens the corresponding subscreen.

⇒ To activate LoadMatch, tap the On/Off button on the left next to the «Cable length» input field.

For applicable loudspeakers, the d&b LoadMatch function enables the amplifier to electrically compensate for the properties of the loudspeaker cable used. This function, which covers a bandwidth of up to 20 kHz, preserves the tonal balance when cable lengths of up to 70 m (230 ft) are used.

LoadMatch does not require an additional sense wire and is therefore applicable with any connector type used.

To provide optimum compensation, LoadMatch requires the entry of the following three parameters:

Cable length Length of the cable in meters in steps of 5 m.
 ⇒ The corresponding length in "ft" is displayed on the bottom left of the input field.

Speaker count Number of cabinets connected.

Cross-section Cross section in square millimeters (mm²) in steps of 0.5 mm² up to a maximum of 10.0 mm².
 ⇒ The corresponding "AWG" value is displayed on the bottom left of the input field.
 ⇒ The resulting cable impedance is shown as an ohmic value in the «Cable impedance» information field underneath.

Maximum gain reached

Depending on the LoadMatch settings, the message «Maximum gain reached» indicates the limit up to which the LoadMatch function works.

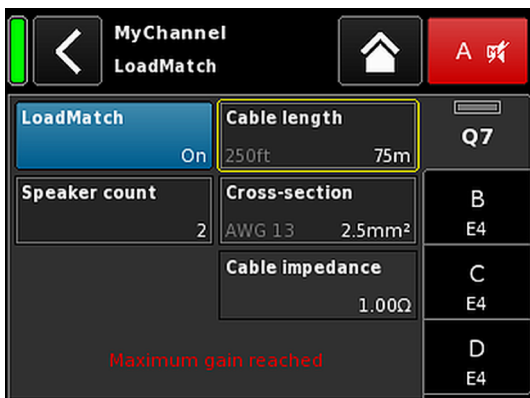

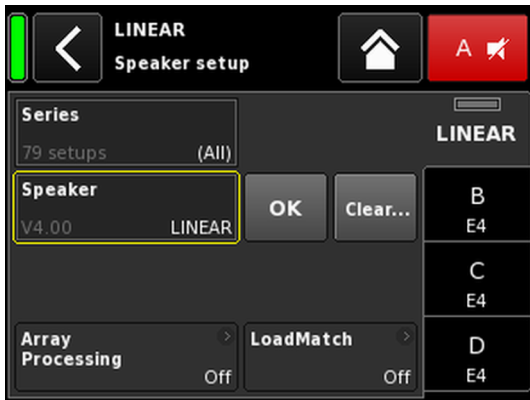

12.8.3. LINEAR setup

In addition to the loudspeaker specific setups, a LINEAR setup is also available allowing the D20 to be used as a linear power amplifier.

Note: CUT in LINEAR setup:

- Butterworth 2nd order (12 dB/oct.)
- Corner frequency: 110 Hz
- Amplifier gain @ 0 dB: 31 dB.

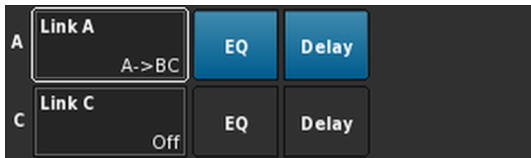
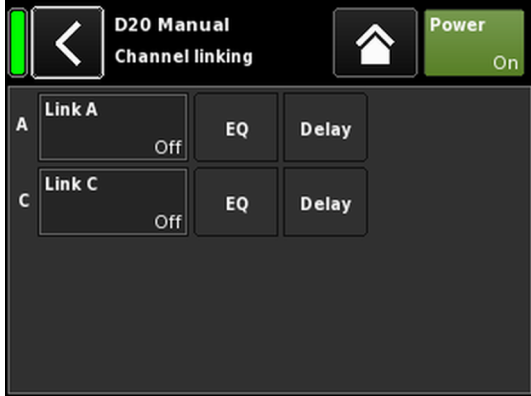

12.9. Channel linking

Selecting «Channel linking» opens the corresponding subscreen.

Provided the amplifier's output mode is set to Dual Channel and/or Mix TOP/SUB mode, the «Channel linking» function allows either channel EQ and/or Delay settings to be linked.

There are four direction modes:

- A ⇒ B
- A ⇒ BC
- A ⇒ BCD
- C ⇒ D

The linked functions can then be controlled from the «Channel» menu of channel A and/or C, while these functions are disabled in the «Channel» menus of channels B and D.

When choosing either «A ⇒ BC» or «A ⇒ BCD», the «Link C» function is disabled (set to «off»).

However, when activating «Link C» while «Link A» is set as described above, the «Link A» function is disabled correspondingly.

In the «Channel» menu, this status is indicated by a horizontal eight («∞»), as shown in the graphic opposite.

The On/Off status of the link function is indicated in the respective channel menu, as shown in the graphic opposite.

Example

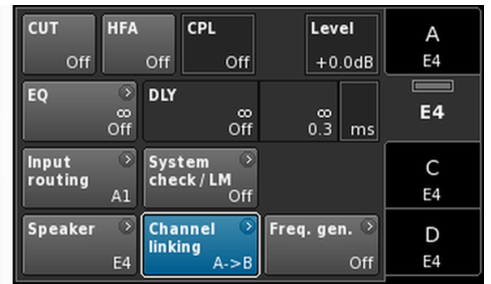

Channel linking:

EQ A ⇒ B; EQ and Delay C ⇒ D

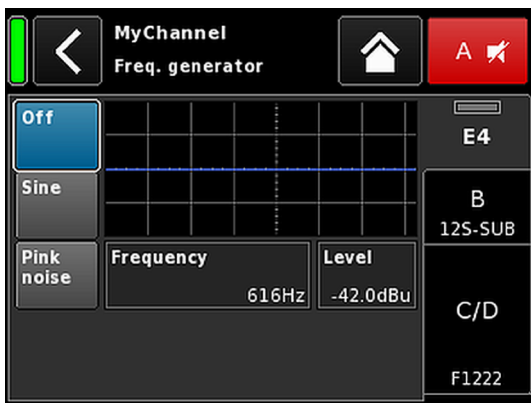
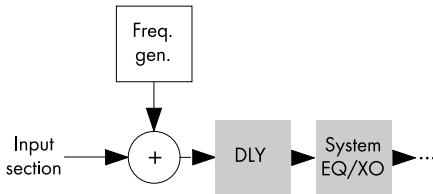

12.10. Frequency generator - Freq. gen.

Selecting «Freq. gen.» opens the corresponding subscreen.

Each amplifier channel is equipped with an independent signal generator offering sine wave or pink noise signals.

The generator provides pure-spectral sine wave signals with high frequency accuracy and free of harmonics.

The generator can be used to check the connected loudspeakers or to identify room resonances, for example.

The generator is inserted in the signal path after the input section and before the actual signal processing. The test tone will sum up with any input signal present.

Note: As a precautionary measure, the frequency generator is always set to Off after the device is powered on.

Off The frequency generator is switched off (Bypass).

Sine/ Pink noise To turn the frequency generator on, select either «Sine» or «Pink noise», depending on the desired signal.

Frequency The frequency is adjustable from 10 Hz to 20 kHz.



On the top right of the «Frequency/FRQ» input field, the increment is displayed as an octave value. When you tap the field for the first time, the frequency increment is set to 1/6 octave. When you tap the field again, you can toggle between 1/6 and 1/96 octave increments.

To confirm the set frequency, press the encoder.

Level The level in dBu is adjustable from -57.5 dB to +6 dB in 0.5 dB steps.

The level value corresponds to the level at the controller signal input. The actual output voltage depends on the channel input gain, the frequency dependent gain of the selected loudspeaker setup and the EQ settings, if applicable.

On the Home screen, the On/Off status of the generator is indicated by the entry «FG» on the Channel view button of the corresponding channel strip, as shown in the graphic opposite.

13. Web Remote interface

In addition, a Web Remote interface is integrated which provides direct access to the user interface of a single amplifier using a standard web browser.

Note: The user interface of the amplifier can only be accessed after connecting the amplifier to a computer via Ethernet. It is possible to connect the computer and the amplifier directly, however, this requires to manually set static IP addresses.

For this reason, the use of a router with DHCP server is recommended for setting up the network connection. If the router also provides a wireless access point, the amplifier may also be controlled using mobile devices.

Recommended and tested browser

Windows: Firefox V 7.0 or higher
Internet Explorer: None

OSX: Safari V 5.0 or higher
Firefox V 7.0 or higher
Internet Explorer: None

iOS: iOS 6 or higher

Android: Mobile Firefox V 27.0 or higher

Remote control

To enable remote control via the Web Remote interface, proceed as follows:

1. Establish a connection between the etherCON connector of the amplifier and the router.
⇒ Up to three (3) amplifiers may be daisy chained to connect to one single port of the router.

After a while, the «Remote» tab of the amplifier screen will display the IP address the DHCP server has assigned to the device.
2. Type this address into the address field of the browser or the mobile device that is connected to the network.
⇒ In this case: **192.168.11.194**
3. For multiple amplifiers, open one browser tab for each amplifier connected and apply the corresponding IP address.

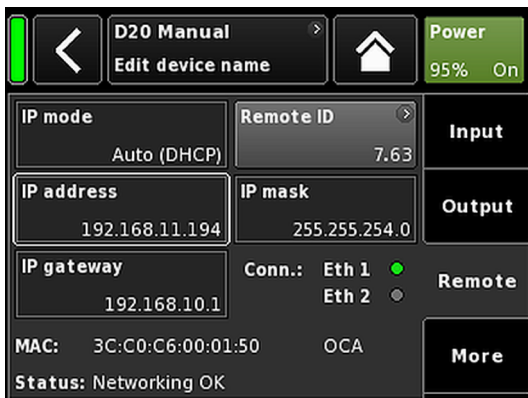



Web Remote interface page

The Web Remote interface page is split into three tabs: the «Web Remote», the «Event log» and the «Commands» tabs.

Web Remote tab

The «Web Remote» tab shows the actual screen of the connected amplifier.

All screens and screen items can be accessed by simply clicking the relevant item.

Refresh slow

The default refresh rate is 30 seconds. This setting is recommended for larger amplifier networks in order to minimize network traffic. However, when you click any screen item, the corresponding item will be refreshed as fast as possible (approx. within one second).

Selecting «Refresh slow» will change the button to «Refresh fast» and the refresh rate will be one second.

Edit

For applicable parameters, the «Edit» button becomes accessible and a corresponding dialog will pop up.

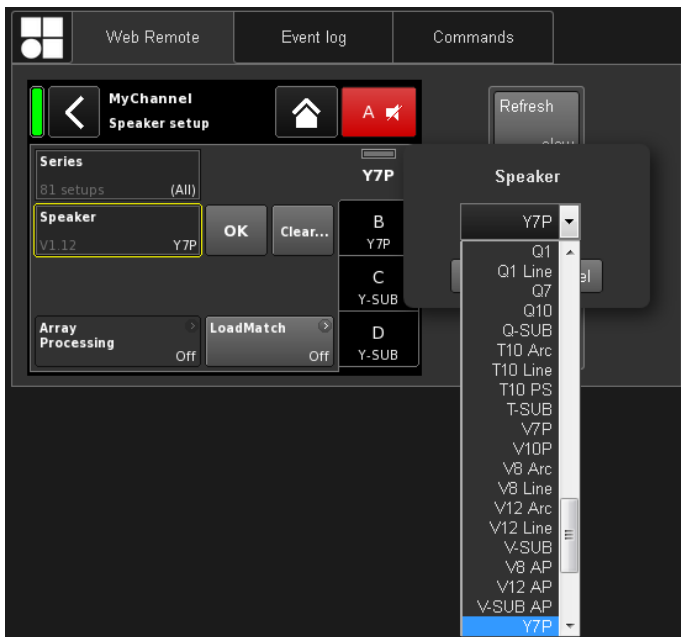
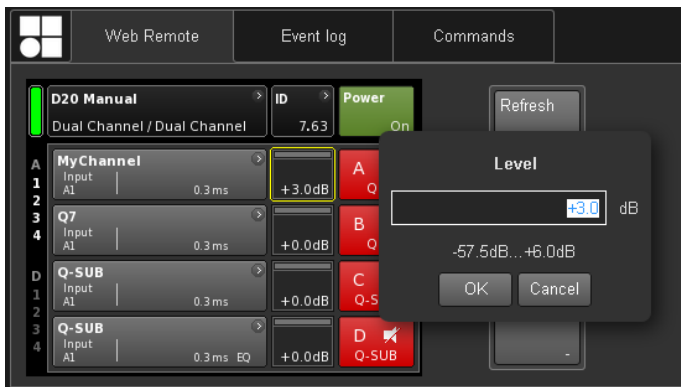

Edit dialog

To change the value of an input field such as CPL, Level, Delay time, EQ settings or Speaker setup, proceed as follows:

1. Enter the desired value or select the respective item from the drop-down list.
2. Confirm your entry by clicking «OK».
 - ⇒ The entered value or selected list item will be applied and the «Edit» dialog will be closed.

Note: However, please note that you have to finally confirm your settings by clicking the respective «OK» button or input field again (Edit cursor changes from yellow to white ⇒ Position cursor).

Drop-down list

For parameters such as «Speaker setup» or «Filter type» a drop-down list is provided to allow easy and quick access to the list items.

You can simply scroll through the list or type the corresponding character directly into the input field.



Value +/ Value -

Additional editing

To change the value of an input field such as CPL, Level, Delay time, EQ settings or Speaker setup using the «Value +»/«Value -» buttons, proceed as follows:

1. Select the appropriate field and change the value using the «Value +»/«Value -» buttons.
 - ⇒ Every mouse click will increment the «Value +»/«Value -» by 0.5.
 - For example, to increase the level by 3 dB, simply click the «Value +» button six times or simply hold the mouse button until the amount of steps has been reached.
 - On the left, a blue counter box will appear showing the number of steps.
2. When the desired value (steps) has been reached, stop clicking or release the mouse button respectively.
 - ⇒ The counter box moves to the input field previously selected.
3. As an alternative, values can also be adjusted using the wheel mouse.
 - ⇒ Simply select the appropriate field and adjust the value using the wheel. This is very useful when entering major changes.
 - The counter field will also appear and behaves in the same manner as described above.
4. To confirm the set value, click the relevant field again or click the respective «OK» button.
5. To change/enter a device or Channel name as well as IP settings, click the relevant screen item.
 - ⇒ An input mask will be displayed which allows you to enter the desired data by clicking the respective characters and/or numbers.
6. Confirm your entry by clicking the corresponding «OK» button.

Keyboard entries

In addition, entries such as Device name or Channel name as well as IP addresses can also be entered using the keyboard. However, depending on the behavior of the browser or its settings, some characters may not be accepted or may change the focus.

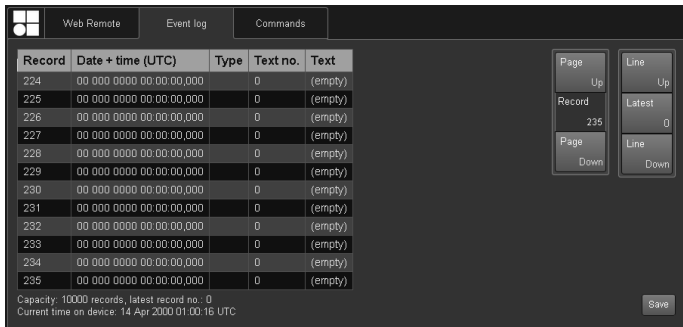

Event log tab

The «Event log» stores a maximum of 10000 records. Once the maximum number of records is reached, the system starts deleting the first ones ⇒ Ring buffer.

The number of records displayed depends on the size of the browser window.



Located on the right-hand side of the record list are various Navigation buttons allowing you to scroll through the list using the «Page Up/Down» or «Line Up/Down» buttons or by directly jumping to the «Latest» record.

In addition, the editable «Record» field allows you to enter a dedicated record number. The corresponding record will be displayed at the very bottom of the record list.

Storage option (Save)

In addition, a storage option is provided which allows you to store the Event log data locally. This is mainly intended for service and/or troubleshooting purposes.

To save the Event log data locally, proceed as follows:

1. Select the «Save» button at the bottom right corner of the web browser window.
⇒ A corresponding dialog will pop up providing you with a drop-down list from which you can select either the number («Last [n]») of records or «All» records to be saved.

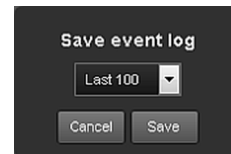

2. Choose the desired option from the drop-down list and select «Save».
⇒ The event log data will be downloaded and the download progress will be displayed.

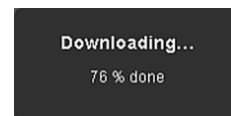

Once the download is completed, a corresponding message will be displayed.

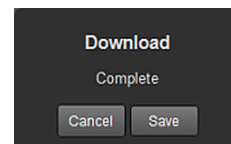

3. Select «Save» to store the Event log data locally.
⇒ Your web browser will display the corresponding dialog and the file will be saved as **Event.log** to the local download directory you have specified in the download settings of your browser.



Commands tab

This functionality is intended for service purposes only

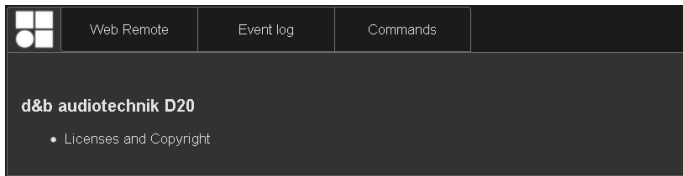

Licenses and Copyright

Selecting the d&b logo at the top left opens the «Licenses and Copyright» information page.

14.1. Power supply

The device utilizes a universal range switch mode power supply with active Power Factor Correction (PFC).

The power supply is equipped with mains voltage monitoring, overvoltage and undervoltage protection as well as an inrush current limiter.

14.1.1. Active Power Factor Correction (PFC)

The active Power Factor Correction provides a clean and highly efficient sinusoidal current draw, thus providing highest performance under adverse mains conditions or when very long power cabling is necessary.

The power factor is above 0.9 for mains power consumption values of 500 W or higher.

14.1.2. Mains voltage monitoring

The mains voltage and frequency are recorded by the power supply and can be viewed on screen. Where voltages outside of this range are present, a self-resetting protective circuit responds quickly to isolate the internal "Main Power Supply" leaving only a supervisory circuit running to monitor the mains voltage. The device accepts mains voltages of up to 400 VAC_{RMS} without damage to the device in case of a missing neutral line or running phase to phase.

14.1.3. Rated mains voltage

The power supply enables the device to be used with any mains supply worldwide without the need for manual action.

The power supply incorporates a "Mains Power Supply" and an "Auxiliary Power Supply".

Mains Power Supply

The Mains Power Supply feeds the power amplifiers within the nominal mains range of 100 to 240 V.

Auxiliary Power Supply

The Auxiliary Power Supply feeds the DSP section and the device control and operates within the range from 55 VAC_{RMS} to 400 VAC_{RMS}.

Behavior with fluctuating mains voltages

With mains voltages other than the nominal voltages specified above, the device switches to the adequate mode for either "Standby" (Protection) or "Operation".

The voltage thresholds are dependent on the slope of the mains voltage change.

┌ 55	←	75	←	266	←	400
Undervoltage Standby (Protection)		Operation		Overvoltage Standby (Protection)		
55 └	⇒	85	⇒	276	⇒	400

Overvoltage Undervoltage

Depending on the operating state, the device will be switched to Standby mode (Protection).

NOTICE!

In **Overvoltage** state with mains voltages above 400 V, damage to the device cannot be excluded.

In **Undervoltage** state, the Auxiliary Power Supply for the device control operates down to 55 VAC_{RMS}.

Up to this threshold ...:

- The display remains active and the device can be operated locally.
- Remote control via web remote or R1 is still possible without restrictions.
- Below this threshold, the device will be switched off.

14.1.4. Mains supply requirements

Due to the high power capability of the amplifier, properly dimensioned mains supply installation and distribution are essential.

However, the mains supply benefits from the built-in active PFC (Power Factor Correction) function of the amplifier, which causes an almost ideal (sinusoidal) current shape. Power losses of the mains supply and cables are kept to the lowest possible minimum.

To ensure safe and stable operation, observe the following recommendations and specifications:

- When three amplifiers are operated with a three-phase (120°) mains supply, the current on the N (neutral) conductor can be minimized by matching loads and signals between the three devices.
- Keep the supply line as short as possible and its cross section as high as possible. Voltage drop at full load should not exceed 5 %.

14.1.5. Generator operation/UPS requirements

To operate the amplifier using a mains generator or uninterruptible power supply (UPS), observe the following:

- With the D20 amplifier the apparent power figure (VA value) is about the same as the effective power figure (W value).
- Use a generator or UPS that can deliver the maximum power required by the entire system. Assume a short time power draw of 2.2 kVA per D20. This is particularly important when using a UPS without dedicated short-time overload capability.
- Run the generator or UPS at 220 to 240 V, if available. 50 or 60 Hz is not an issue.

14.2. Power amplifiers

The power amplifiers fitted to the D20 utilize Class D technology similar to a switch mode power supply. Compared to the known linear amplifier concept (Class A, AB, G or H), Class D power amplifiers produce less heat and allow for a compact and light-weight design.

While supplying very high maximum output swing, it maintains high efficiency with any kind of signal and load and runs as cool as possible. Channels share the same power supply and are thermally coupled to provide even higher average power figures when unevenly loaded. TOP/SUB setups and active cardioid subwoofers are cases of typical use. A sophisticated circuit design decreases the impact of the load on the amplifier performance and enables a well defined sound reproduction. A comprehensive set of protection features individually prevents each channel from overload and/or damage/defect. Channels that are not affected will continue to operate, if safely possible.

14.3. Cooling fans

Two temperature and level controlled fans are incorporated for cooling the internal components, which allows greater cooling during louder program material. The fan speed is consequently reduced during quieter passages preventing background noise interference. If the unit heats up a «Temp. Warning» is issued and the fans will give full cooling power permanently.

14.4. Current/power draw and thermal dissipation

Measurement references

Signal CF 12 dB: Represents 1/8th of the nominal power.

Signal CF 9 dB: Represents 1/4th of the nominal power; power is limited to the nominal line current.

Continuous (cont.): Unlimited time. Thermal conditions may affect power figures.

Maximum (max.): Values are measured 1 sec. after signal was applied.

Sine wave (Max. 1 s / 10 %): 1 kHz Sine wave with (voltage) CF 3 dB / 1.4, resp. Represents the highest line current draw.

230 VAC / 50 Hz / 0.5 Ω Source impedance								
Mode/Signal	Load	Line current A_{RMS}	Power factor	Input power W	Output power (sum.) W	Power loss W	Thermal dissipation BTU/hr	Thermal dissipation kCal/hr
OFF	-	0.25	0.09	5	0	5	16	4
Standby	-	0.27	0.23	14	0	14	48	12
Idling	-	0.41	0.49	46	0	46	197	40
Signal CF 12 dB cont.	4 Ω/Ch.	4	0.95	900	650	250	853	215
Signal CF 9 dB cont.	4 Ω/Ch.	5.65	0.93	1300	980	320	1092	275
Signal CF 9 dB max.	4 Ω/Ch.	8.9	0.97	2010	1406	604	-	-
Sine wave CF 3 dB Max. 1 s / 10 %	4 Ω/Ch.	16.2	-	-	-	-	-	-

208 VAC / 60 Hz / 0.5 Ω Source impedance								
Mode/Signal	Load	Line current A_{RMS}	Power factor	Input power W	Output power (sum.) W	Power loss W	Thermal dissipation BTU/hr	Thermal dissipation kCal/hr
OFF	-	0.2	0.09	4	0	4	14	3
Standby	-	0.3	0.23	13	0	13	44	11
Idling	-	0.41	0.52	45	0	45	152	38
Signal CF 12 dB cont.	4 Ω/Ch.	4.5	0.96	900	645	255	870	219
Signal CF 9 dB cont.	4 Ω/Ch.	6.6	0.97	1350	1000	350	1194	301
Signal CF 9 dB max.	4 Ω/Ch.	9.76	0.98	1987	1383	604	-	-
Sine wave CF 3 dB Max. 1 s / 10 %	4 Ω/Ch.	17	-	-	-	-	-	-

120 VAC / 60 Hz / 0.2 Ω Source impedance

Mode/Signal	Load	Line current A_{RMS}	Power factor	Input power W	Output power (sum.) W	Power loss W	Thermal dissipation BTU/hr	Thermal dissipation kCal/hr
OFF	-	0.18	0.07	1	0	1	3	1
Standby	-	0.2	0.31	8	0	8	27	7
Idling	-	0.5	0.66	39	0	39	133	34
Signal CF 12 dB cont.	4 Ω /Ch.	7.5	0.99	890	640	250	853	215
Signal CF 9 dB cont.	4 Ω /Ch.	8.7	0.99	1040	760	280	955	241
Signal CF 9 dB max.	4 Ω /Ch.	16.5	0.99	1980	1380	600	-	-
Sine wave CF 3 dB Max. 1 s / 10 %	4 Ω /Ch.	20.7	-	-	-	-	-	-

100 VAC / 60 Hz / 0.2 Ω Source impedance

Mode/Signal	Load	Line current A_{RMS}	Power factor	Input power W	Output power (sum.) W	Power loss W	Thermal dissipation BTU/hr	Thermal dissipation kCal/hr
OFF	-	0.2	0.07	1	0	1	3.4	0.9
Standby	-	0.2	0.35	7	0	7	25	6.4
Idling	-	0.5	0.71	37	0	37	126	32
Signal CF 12 dB cont.	4 Ω /Ch.	9.4	0.99	940	680	260	887	224
Signal CF 9 dB cont.	4 Ω /Ch.	9.7	0.99	970	680	290	989	249
Signal CF 9 dB max.	4 Ω /Ch.	21.4	0.99	2140	1372	768	-	-
Sine wave CF 3 dB Max. 1 s / 10 %	4 Ω /Ch.	22.6	-	-	-	-	-	-

15.1. Service



CAUTION! Potential risk of explosion.

The device incorporates a lithium battery which may cause danger of explosion if not replaced correctly.

- Refer replacement only to qualified service personnel authorized by d&b audiotechnik.
- Only replace with the same type of battery.

Do not open the device. No user serviceable parts inside. In case of any damage do not operate the device under any circumstances.

Refer servicing only to qualified service personnel authorized by d&b audiotechnik. In particular if:

- objects or liquids have entered the device.
- the device does not operate normally.
- the device was dropped or the housing is damaged.

15.2. Maintenance and care

During normal operation, the amplifier provides maintenance-free service.

Due to the cooling concept, no dust filters are required. As a result, filter exchange or cleaning is not necessary.

After a certain period of time, the touch screen may require cleaning or calibration.

For this purpose, proceed as follows:

15.2.1. Touch screen cleaning

If the touch screen requires cleaning ...:

- use a soft cloth only.
- do not use any solvent cleaners.

For cleaning very heavy dirt on the panel, it may be helpful to use a special cleaning spray for TFT screens. In this case proceed as follows:

1. Spray on the soft cloth before wiping the screen.
⇒ Never apply/spray directly on the screen as the liquid could penetrate the device.
2. Wipe the screen with moderate pressure.

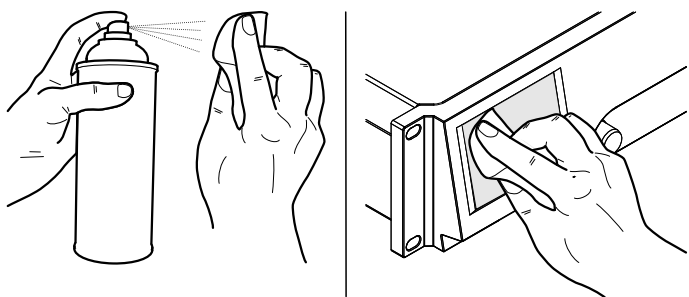

15.2.2. Touch screen calibration

Indication

Due to mechanical impact or the aging process of the touch screen, its calibration references may change.

An indication is that when you tap a specific button and the adjacent button is activated instead or when a specific button does no longer work.

In such cases, the touch screen should be recalibrated.

Calibration

To calibrate the Touch screen proceed as follows:

1. From the «Home screen» go to "«Device setup» ⇒ «More» ⇒ «Preferences» ⇒ «Display»".
2. Select «Touch screen calibration».
⇒ The Screen calibration menu will be opened guiding you through the calibration procedure.
3. Follow the on screen instructions respectively.

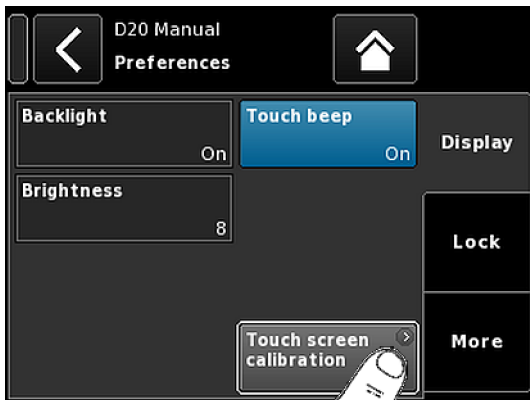



16.1. EU declaration of conformity (CE symbol)

This declaration applies to:

d&b D20 Amplifier, Z2750

manufactured by d&b audiotechnik GmbH.

All products of type D20 starting from variant Z2750.000 are included, provided they correspond to the original technical version and have not been subject to any later design or electromechanical modifications.

We herewith declare that said products are in conformity with the provisions of the respective EC directives including all applicable amendments.

A detailed declaration is available on request and can be ordered from d&b or downloaded from the d&b website at: www.dbaudio.com.

16.2. WEEE Declaration (Disposal)

Electrical and electronic equipment must be disposed of separately from normal waste at the end of its operational lifetime.

Please dispose of this product according to the respective national regulations or contractual agreements. If there are any further questions concerning the disposal of this product, please contact d&b audiotechnik.

16.3. Licenses and Copyright

This device includes software components released under different open source licenses. These components are supplied together with the d&b firmware.

A list of the components and a full-text version of all licenses and copyrights can be accessed using the amplifier's Web Remote interface as described in ⇒ Chapter 13. "Web Remote interface" on page 78.

⇒ Selecting the d&b logo at the top left of the «Web Remote» interface page opens the «Licenses and Copyright» information page.

This page provides an overview of the open source software used in this product. As required by the GPL and LGPL licenses, we will send you a copy of the used source code on request. If you would like to obtain a copy, please contact us by mail to:

d&b audiotechnik GmbH
Eugen-Adolff-Strasse 134, D-71522 Backnang, Germany
T +49-7191-9669-0, F +49-7191-95 00 00, info@dbaudio.com

or by email at: software.support@dbaudio.com

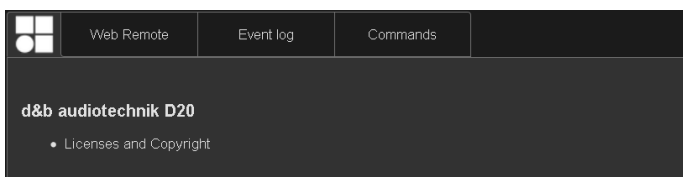

17.1. System check - References

17.1.1. Typical impedance (Z) values

The following table indicates typical impedance values in ohms for d&b loudspeakers. With correct measurement conditions and relatively short cables, measured impedances should be within a range of $\pm 20\%$ of the values indicated in the table.

The values refer to a single cabinet. When two cabinets are connected in parallel, the total impedance is halved, with three cabinets it will be a third and so on.

Note: Please note that the LF values were determined by the amplifiers' measurement algorithms using sine wave signals. A DC resistance measurement using a multimeter may produce different results.

D20 amplifiers apply audible low level signals in the Low frequency range for a few seconds using dedicated frequencies for each cabinet type. This reduces the impact of ambient temperature and mechanical aging of the driver components on the impedance values.

System	Z LF	Z HF	Z MF/LF rear
16C	7.5	12	-
24C	12	11	-
24C/CE	7	11	-
10AL/10AL-D	17	13	-
10S/S-D/A/A-D	17	13	-
12S/S-D	7	11	-
12S-SUB	8	-	-
18S/A-SUB	6.5	-	-
27S/A-SUB	5	-	-
4S	17	11	-
5S	16	11	-
8S	10	15	-
B1-SUB	4.5	-	-
B2-SUB	3.5	-	-
B22-SUB	3.5	-	-
B4-SUB	5	-	-
B6-SUB	6.5	-	-
C3	8.5	4	-
C4-TOP	11	12	-
C4-SUB	6.5	-	-
C6/690	9	15	-
C7-TOP	7	8	-
C7-SUB	6	-	-
Ci-SUB	9	-	-
Ci45/60/90	7.5	13	-

System	Z LF	Z HF	Z MF/LF rear
Ci80	11	16	-
E0	12	11	-
E12/12-D	7	13	-
E12-SUB	8.5	-	-
E12X-SUB	8.5	-	-
E15X-SUB	7.5	-	-
E3	16	21	-
E4	17	11	-
E5	16	12	-
E6	24	20	-
E8	13	16	-
E9	9	13	-
F1222	8.5	15	-
M4	7	13	-
M6	8	13	-
MAX	7	15	-
MAX2	6.5	15	-
MAX12	7.5	14	-
Q1/7/10	7	12	-
Q-SUB	6.5	-	-
T10	14	16	-
T-SUB	6.5	-	-
V7P/V10P	7	17	-
V8/V12	8	18	-
V-SUB/V-GSUB	5.8	-	-
Y7P/Y10P	9	20	-
Y8/Y12	10	20	-
Y-SUB	6.5	-	-

17.1.2. Max. number of cabinets operated in parallel

The following table indicates the maximum number of cabinets which can be operated in parallel by one amplifier channel in order to be able to detect a failure of a loudspeaker component.

Note: The thresholds of the System check function defined by the light blue area (-20 % ... +30 %) are also used by Load monitoring to evaluate the system status. Therefore the values in the table also apply to Load monitoring. If more cabinets are operated in parallel, a correct supervision for single component faults is not possible. This is of particular importance for voice alarm and evacuation systems.

System	Failure mode				
	Single cabinet disconnected	HF section of single cabinet	Single HF/MF driver	LF section of single cabinet	Single LF driver
16C	3	3	-	1	-
24C	2	2	-	1	-
24C-CE	1	1	-	1	-
10AL/10AL-D	3	3	-	3	-
10S/S-D/A/A-D	3	3	-	3	-
12S/S-D	2	2	-	2	-
12S-SUB	3	-	-	3	-
18S/A-SUB	3	-	-	3	-
27S/A-SUB	1	-	-	-	1
4S	3	2	-	3	-
5S	3	2	-	3	-
8S	3	2	-	3	-
B1-SUB	1	-	-	-	1
B2-SUB	1	-	-	-	1
B22-SUB	1	-	-	-	1
B4-SUB	2	-	-	2	1
B6-SUB	2	-	-	2	-
C3	2	2	1	2	1
C4-TOP	3	2	-	3	-
C4-SUB	3	-	-	3	-
C6/690	3	2	-	2	-
C7-TOP	3	2	-	3	-
C7-SUB	3	-	-	3	-
Ci-SUB	3	-	-	3	-
Ci45/60/90	3	2	-	3	-
Ci80	3	1	-	3	-
E0	3	2	-	3	-
E12/12-D	3	2	-	3	-
E12-SUB	3	-	-	3	-

System	Failure mode				
	Single cabinet disconnected	HF section of single cabinet	Single HF/MF driver	LF section of single cabinet	Single LF driver
E12X-SUB	3	-	-	3	-
E15X-SUB	3	-	-	3	-
E3	3	2	-	3	-
E4	3	2	-	3	-
E5	3	2	-	3	-
E6	3	2	-	3	-
E8	3	2	-	3	-
E9	3	1	-	3	-
F1222	2	2	-	2	-
M4	3	3	-	3	-
M6	3	2	-	3	-
MAX	3	3	-	3	-
MAX2	3	3	-	3	-
MAX12	3	3	-	3	-
Q1/7/10	3	3	-	3	1
Q-SUB	3	-	-	3	-
T10	3	2	-	3	-
T-SUB	3	-	-	3	-
V8/V12	2	1	1	1	1
V7P/V10P	2	1	1	1	1
V-SUB/V-GSUB	2	-	-	2	1
Y7P/Y10P	2	2	-	2	1
Y8/Y12	2	2	-	2	1
Y-SUB	2	-	-	1	1

17.2. Possible error messages

The following table lists possible error messages appearing on the display ordered by the error Id.

Id	Display text	Eventlog text	Description	Location	Possible reasons
10	System error 8	System error %u (Reboot)	Unexpected CPU reset	DSP	Software or hardware error
11	System error 128	System error %d (I2C, IC 0x%02X, Pos %d)	Internal I2C communication fault	DSP	Any I2C device defect
15	Unknown device type	Unknown device type %d	Unknown device type		
16	Invalid device ident	Invalid device ident %d	Invalid hardware configuration	ADDAC, AMP, SMPS	Missing or wrong module identification
17	Invalid CPLD version	Invalid CPLD version %d (minimum required %d)	Invalid CPLD identification	DSP	Missing or wrong CPLD identification
18	Invalid ADDAC ident	Invalid ADDAC board ident %d	Invalid ADDAC identification	ADDAC	Missing or wrong ADDAC identification
19	Invalid display ident	Invalid display board ident %d	Invalid DISPLAY identification	DISPLAY	Missing or wrong DISPLAY identification
20	Program error %u	Program error %d, %d, %d, %d	Program error	DSP	Various
21	Invalid DSP Data	Invalid DSP database (Position %d, Error %d)	Invalid DSP data	DSP	Software error
25	Program error %u	Program error %d: AWL error %d in AWL %d, line %d	Program error	DSP	Various
28	SMPS comm. error	SMPS communication error (status %04X)	SMPS communication fault	DSP, SMPS	DSP or SMPS defect, cable defect
29	SMPS firmware mismatch	SMPS firmware V%d. %02d.%02d not suitable for hardware ident %d	Invalid SMPS configuration	SMPS	SMPS firmware does not match module identification
30	SMPS temp err %dÅ °C	SMPS temperature error %+3dÅ °C (power %uW)	Mega-Temp-Off		
32	Mains overvoltage >276V	Mains overvoltage >276V (avg %3dV, peak %3dV, status %04X, err %04X)	Mains overvoltage	(External: Mains)	Mains voltage is/was too high
34	Mains undervoltage %dV	Mains undervoltage (avg %3dV, peak %3dV, status %04X, err %04X)	Mains undervoltage	(External: Mains)	Mains voltage is/was too low
45	Amp. comm. error	Amp. communication error (status %04X)	AMP communication fault	DSP, AMP	DSP or AMP defect
46	Amp. firmware is too old	Amp. firmware version %4.2d is too old, required is %4.2d	AMP firmware version is older than required	AMP	AMP software error

Id	Display text	Eventlog text	Description	Location	Possible reasons
50	Invalid device para	Channel '%c': invalid device parameters (device ident %d)	Invalid device parameters	DSP	Software error or wrong device type detected
51	Invalid DSP prog %u	Channel '%c' : invalid DSP program %d	DSP program invalid	DSP	Software error
52	DSP boot error	Channel '%c': DSP boot error (DSP program %d)	DSP boot error	DSP	DSP or software error
58	DSP comm. error	Channel '%c': DSP communication error	DSP communication fault	DSP	DSP defect or software error
59	Invalid setup data	Channel '%c': invalid speaker setup (speaker id %d, no. %d, err %d)	DSP invalid setup data	DSP	Software error
61	Invalid AP slot %d	Channel '%c': invalid AP slot %d (file version %d)	Invalid ArrayProcessing data	(External: AP data file invalid)	Software error
78	Amp. supply fault	Amp. supply fault (status %04X, err %04X, %4.1 dV, %4.1 dV)	AMP rail voltages	AMP	AMP defect
79	Amp. firmware mismatch	Amp. firmware V%d. %02d.%02d not suitable for hardware ident %d	AMP has wrong firmware	AMP	AMP firmware does not support the AMP hardware
87	Amp temp. mute	Channel '%c': Amp. temperature auto shutdown (%dÂ°C)	AMP mute due to high temperature	AMP	Poor cooling
89	Amp. protection	Channel '%c': Amp. protection (power %uW)	AMP channel protection	AMP	cabling or AMP defect
95	Amp. overtemp %dÂ°C	Channel '%c': Amp. overtemperature %dÂ°C (power %uW)	AMP over temperature	AMP	Poor cooling
96	Amp. temp sensor fault	Amp. temperature sensor fault (A %dÂ°C, B %dÂ°C, C %dÂ°C, D %dÂ°C)	AMP temperature sensor fault	AMP	AMP defect
99	Amp. temp warn %dÂ°C	Channel '%c': Amp. temperature warning %dÂ°C (power %uW)	AMP temperature warning	AMP	Poor cooling
120	CAN open error	Could not open CAN interface (error %d)	CAN interface open error	DSP	DSP defect or software error
121	CAN error	CAN error %d (remote flags %02X, dbCan flags %02X)	CAN error	(External: CAN cabling), RemId	CAN cabling or multiple RemIds
122	CAN warning	CAN warning %d (remote flags %02X, dbCan flags %02X)	CAN warning	(External: CAN cabling)	CAN cabling or multiple RemIds

Id	Display text	Eventlog text	Description	Location	Possible reasons
124	OCA remote error	OCA remote error %u	OCA remote error		Software error
150	Speaker imp. fault	(empty)	Load Monitoring impedance error	(External: speaker, cabling)	Speaker defect, cable
153	Amp. low temperature	Channel '%c': Amp. temperature too low (%dÂ°C)	AMP temperature warning	AMP	Ext. conditions, sensor fault
160	Input fallback	Input fallback (A1= %d, A2=%d, D1=%d, D2=%d)	Input fallback was activated	(External: Cabling)	
161	Input monitoring fault	Input monitoring fault A%d (%4.1ddBu, threshold %4.1ddBu)	Input monitoring fault	(External: Cabling)	Cabling or signal source defect
162	Input monitoring fault	Input monitoring fault A%d (%4.1ddBu, threshold %4.1ddBu)	Input monitoring fault		
163	Input monitoring fault	Input monitoring fault A%d (%4.1ddBu, threshold %4.1ddBu)	Input monitoring fault		
164	Input monitoring fault	Input monitoring fault A%d (%4.1ddBu, threshold %4.1ddBu)	Input monitoring fault		
165	Input monitoring fault	Input monitoring fault D%d (lock %d, %4.1ddBFS, threshold %4.1ddBFS)	Input monitoring fault		
166	Input monitoring fault	Input monitoring fault D%d (lock %d, %4.1ddBFS, threshold %4.1ddBFS)	Input monitoring fault		
167	Input monitoring fault	Input monitoring fault D%d (lock %d, %4.1ddBFS, threshold %4.1ddBFS)	Input monitoring fault		
168	Input monitoring fault	Input monitoring fault D%d (lock %d, %4.1ddBFS, threshold %4.1ddBFS)	Input monitoring fault		
169	Ethernet overload	Ethernet overload, throttling active	Ethernet overload		Too much network traffic



